



ISTITUTO NAZIONALE DI RICERCA METROLOGICA Repository Istituzionale

Speed of sound measurements in deuterium oxide (D₂O) at temperatures between (276.97 and 363.15) K and at pressures up to 210 MPa

This is the author's accepted version of the contribution published as:

Original

Speed of sound measurements in deuterium oxide (D₂O) at temperatures between (276.97 and 363.15) K and at pressures up to 210 MPa / Lago, Simona; GIULIANO ALBO, PAOLO ALBERTO; Cavuoto, Giuseppe. - In: FLUID PHASE EQUILIBRIA. - ISSN 0378-3812. - (2020).

Availability:

This version is available at: 11696/65375 since: 2021-01-25T16:16:18Z

Publisher:

Elsevier

Published

DOI:

Terms of use:

This article is made available under terms and conditions as specified in the corresponding bibliographic description in the repository

Publisher copyright

(Article begins on next page)

1 **Speed of sound measurements in deuterium oxide (D₂O) at temperatures between**
2 **(276.97 and 363.15) K and at pressures up to 210 MPa**

3 S. Lago,^{1, a)} P. A. Giuliano Albo,¹ and G. Cavuoto¹

4 *Istituto Nazionale di Ricerca Metrologica, Strada delle Cacce 91, 10135 Torino,*
5 *Italy*

6 This paper presents speed of sound measurements in heavy water (deuterium ox-
7 ide, D₂O) along six isotherms **between 276.97 K and 363.15 K** for pressures up to
8 210 MPa **using a** double *pulse-echo* method. The experimental **apparatus** was **val-**
9 **idated measuring the speed of sound in** ordinary water at ambient pressure and at
10 temperatures between 295.5 K and 363.15 K **with results found in** agreement with
11 values calculated from the reference equation of state for water by Wagner and Pruß
12 **within** 0.005 %. The relative combined expanded uncertainty **of our** speed of sound
13 measurements, at a confidence level of 95 %, is estimated to be less than 0.03 % for
14 pressures up to 10 MPa and in the order of 0.05 % for pressures up to 210 MPa in the
15 whole investigated temperature range. The speed of sound results have been com-
16 pared with values calculated from the reference equation for heavy water the IAPS84
17 Formulation by Hill et al. (1982), and with **the prediction of the** newly developed
18 equation of state for heavy water by Herrig *et al.* (2018). The relative deviations
19 **of these comparison were found to be consistent with the reference equations within**
20 **their combined uncertainty.** The **results presented here were also compared** with the
21 most recent data by Wegge *et al.* **and found to be in agreement within** 0.05 %.

22 **Keywords:** Speed of sound, deuterium oxide, heavy water, high pressure

^{a)}Electronic mail: s.lago@inrim.it

23 I. INTRODUCTION

24 Liquid deuterium oxide (often referred to as heavy water) is of interest in various scientific
25 fields for its numerous applications, e.g. to study mechanisms and rates of chemical or nuclear
26 reactions, for diagnostics in nuclear magnetic resonance, as well as in biological processes
27 and as coolant and moderator in pressurized heavy-water reactor (PHWR) of nuclear power
28 plants. A dedicated equation of state (EoS) is a useful tool to represent the ensemble of
29 thermodynamic properties needed to develop novel technological and industrial solutions.
30 The dedicated EoS of a fluid can reach high accuracy when also caloric properties (such as
31 speed of sound and specific heat capacity) are included in its implementation. High pressure
32 speed of sound measurements are of special interest because, being linked to both calorific
33 and mechanical properties of the fluid, they drive the choice of the number of terms that
34 are included in the equation of state and allow to improve its accuracy, and the physical
35 behaviour. Differently from the case of water, the thermodynamic properties of heavy water
36 are far less studied and measurements are usually affected by a larger uncertainty. The
37 measurement accuracy significantly improves for atmospheric pressure measurements and
38 a complete list of references of these measurements is reported in Table 13 of Herrig *et*
39 *al.*¹ Anyway, since in this work the minimum pressure has been limited to 0.2 MPa (for
40 preventing the possible contamination of the fluid), a direct comparison with the results
41 reported at 0.1 MPa is not possible, unless by extrapolation.

42 Considering high pressure speed of sound measurements the availability of published
43 papers reduces to few works. In this case, mention is worth for the speed of sound results
44 obtained by Wilson² or by Chen and Millero³ up to 100 MPa, those obtained by Aleksandrov
45 and Larkin⁴, and the very accurate values by Wegge, Richter and Span (2016)⁵. Some of
46 these data have been used by Hill *et al.*⁶ to implement a fundamental equation of state, any-
47 way that equation has a limited range of validity with a lower limit temperature of 276.97 K
48 and a maximum pressure of 100 MPa. More recently, a more accurate reference equation
49 of state has been implemented by Herrig *et al.*¹, but a definitive uncertainty estimation for
50 pressures above 100 MPa is not possible, because speed of sound data were not available in
51 this high pressure region. Motivated by this limited framework, we carried out more than
52 seventy experimental speed of sound measurements in heavy water (deuterium oxide, D₂O;
53 purity: 99.85 % D atoms, deuterium atoms fraction), as reported and discussed in the rest

54 of this work. Our experimental results have been obtained along six isotherms ranging from
55 (276.97 to 363.15) K and for pressure up to 210 MPa. The results presented here are the
56 only data available in this range of pressure, making them useful to improve and update a
57 new dedicated equation of state¹ or, at least, they contribute to validate the equation and
58 provide an estimation of its accuracy when thermodynamic properties are extrapolated.

59 II. EXPERIMENTAL SECTION

60 Speed of sound was measured by a double *pulse-echo* ultrasonic technique. The core
61 of the experimental apparatus, used for the determination of the phase velocity of the
62 ultrasonic waves, is a cylindrical stainless steel cell supplied with two reflectors placed at
63 unequal distances from a single piezoelectric transducer. The main features of the apparatus
64 design (with regard to the dimensions, constructing materials, gaskets, and because of the
65 absence of moving parts) make it a versatile instrument **which can be operated** over a wide
66 range of temperatures and pressures. The double *pulse-echo* method is based on direct
67 measurement of the **time delay** between echoes coming from the different reflectors. In a
68 previous paper⁷, details about the ultrasonic cell and the associated experimental apparatus
69 are provided. The adopted measurement design allows to compensate the effects due to
70 the trigger and electrical line delays but, even more **importantly**, this configuration allows
71 to obtain a repeatability of the time-of-flight measurements in the order of 10 parts per
72 million since **tone bursts** have very similar shapes. In figure 1, a geometrical **sketch** of
73 the measurement cell is shown. The nominal lengths of the spacers, separating the source
74 (red) from the reflectors are $L_1 = 45$ mm and $L_2 = 67.5$ mm. The acoustic path length **was**
75 **estimated by the results of a calibration based on speed of sound measurements in** high-purity
76 ordinary water (H_2O) at seven different temperatures (295.5, 303.15, 304.0, 319.0, 323.15,
77 343.15, 363.15) K and ambient pressure, with reference speed of sound values obtained from
78 the IAPWS-95 formulation⁸.

79 Additional **experimental** tests have been carried out to verify that calibrated ΔL ($\Delta L =$
80 $L_2 - L_1$) **did not vary, depending on the** carrier frequency adopted to generate the signal.
81 Three different runs have been performed using tone-burst of 5 cycles with a carrier frequency
82 of 4 MHz and three **additional** runs with a carrier frequency of 8 MHz. Since the frequency
83 dependence of the time-of-flight **has been verified to be** negligible, when compared to other

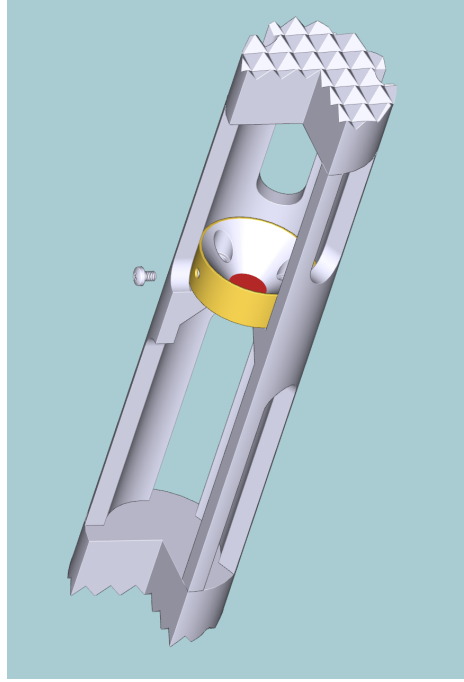

Figure 1. Layout of the ultrasonic measuring sensor¹⁰.

$p = 0.1$ MPa	$2\Delta L$ / mm	$2\Delta L$ / mm	Relative	$2\Delta L$ / mm
$T = 294.95$ K	Calibration 1	Calibration 2	deviations	Mean value
	(3 runs)	(3 runs)		
$f = 4$ MHz	43.8029	43.8017	0.0026 %	43.8023
$f = 8$ MHz	43.8047	43.8037	0.0022 %	43.8042
Relative deviation				0.0043 %

Table I. Results of the cell calibration procedure obtained using different carrier frequencies.

84 sources of uncertainty, the speed of sound measurements were eventually performed at
 85 4 MHz. To minimize the effect of temperature drifts in the order of a few millikelvin, the
 86 calibration has been repeated three times and the results have been averaged. All these
 87 preliminary tests were carried out at ambient pressure and $T = 294.95$ K. The results have
 88 been summarized in Table II. In figure 2 the overlapping of the two echoes (black and gray)
 89 obtained at 4 MHz (a) and at 8 MHz (b) are shown.

90 The relative deviations of our experimental results (w_{INRiM}) from w_{EoS} , such as the speed
 91 of sound values calculated with the equation of state (EoS) of Wagner and Pruf⁸, are
 92 plotted as a function of the temperature in figure 3. The uncertainty declared by Wagner

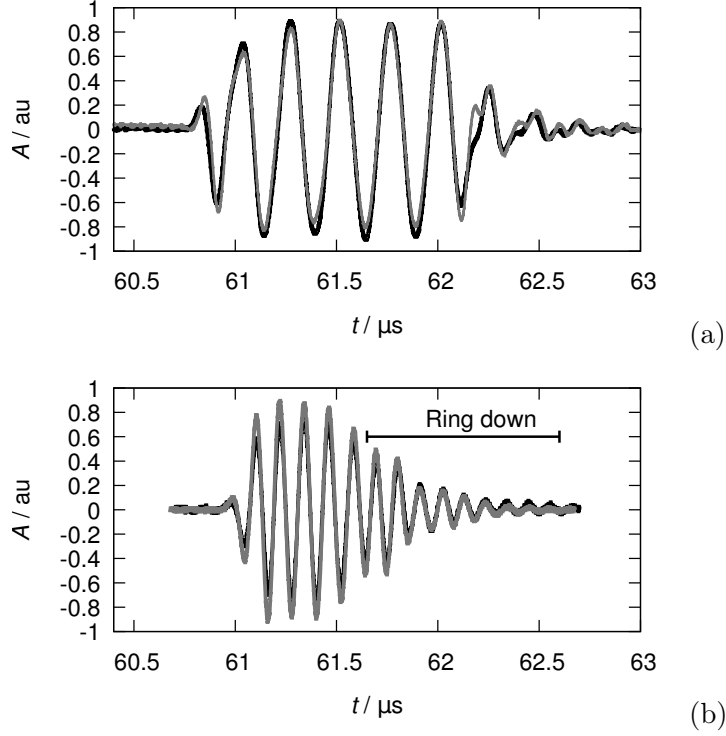

Figure 2. Plots of the five-cycles tone-bursts obtained with a 4 MHz carrier frequency (a) and 8 MHz (b) using a wide-band piezoelectric source with nominal resonant frequency of 8 MHz.

93 and Pruß for the [speed of sound predicted by equation](#), in the specific considered region, is
 94 only 0.005 %. [Remarkably, all our experimental results](#) are in a good agreement with the
 95 reference equation of state.

96 The piezoelectric transducer [is excited](#) with an electrical signal [from a function generator](#)
 97 in the form of five-cycles repeated tone-bursts with a carrier frequency of 4 MHz and an am-
 98 plitude of 10 Vpp. The waveforms, including both echoes, have a duration of approximately
 99 100 μs and are digitized at a sampling rate of 4×10^9 samples per second. [By analyzing](#)
 100 [the sampled signals, the time-of-flight \$\tau_{exp}\$ of the ultrasonic waves that travelled twice the](#)
 101 [distance separating the source and reflectors is determined.](#) The speed of sound, w_{exp} , is
 102 [then](#) obtained from the following expression:

$$w_{exp} = \frac{2\Delta L}{\tau_{exp}}, \quad (1)$$

103 where ΔL is the difference in the acoustic paths travelled by the first two echoes coming from
 104 different reflectors and τ_{exp} is the corresponding time delay. The time delay is determined
 105 on the basis of the digital signal $P_1(t)$, representing the first sampled echo from the nearest

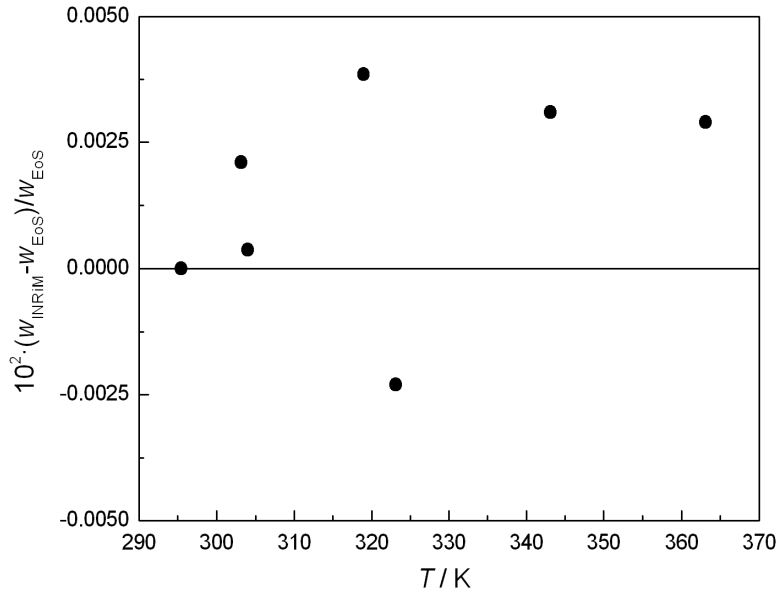

Figure 3. Results of the calibration of the speed of sound sensor in ordinary (light) water at $p = 0.098$ MPa. Relative deviations of experimental speeds of sound w_{INRiM} from values w_{EoS} calculated with the EoS of Wagner and Pruß⁸ are plotted as a function of the temperature T

106 reflector, and the echo $P_2(t + \tau)$, from the farthest reflector, by means of a correlation
 107 function $C(\tau)$ defined as:

$$C(\tau) = \int_{-\infty}^{\infty} P_1(t)P_2(t + \tau)dt, \quad (2)$$

108 that has the property to show an absolute maximum at the value of τ equal to the time delay
 109 between the two echo waveforms. A detailed explanation of this method and the associated
 110 signal-to-noise ratio are discussed in Benedetto *et al.*⁷.

111 Experimental measurements of times-of-flight and travelled path-lengths can be used to
 112 determine the speed of sound after [keeping into account relevant corrections](#). In Lago *et*
 113 *al.*⁹, it is shown how the finite dimensions of the source prevent the complete cancellation of
 114 [the phase shift affecting the wave-fronts spreading into the measurement cell](#). The described
 115 [diffraction effects perturb the measurement of the time-of-flight, which is accounted by](#)
 116 [correcting the expression used to determine the speed of sound as follows](#):



Figure 4. Wide-band ceramic PZT “DuraAct” kapton encapsulated.

$$w_{\text{exp}} = \frac{2\Delta L}{\tau_{\text{exp}} + \delta\tau}, \quad (3)$$

117 where the correction term $\delta\tau$ comes from the wave-like nature of the spreading signal. The
 118 diffraction of the generated signal appears in the form of a phase advance of the ultrasonic
 119 pulses, relative to a perfectly plane wave traversing the same distance with resulting effects
 120 on $\delta\tau$ which can be calculated using an appropriate model⁹.

121 For speeds of sound, measured at temperature T and pressure p which differ from the
 122 calibration conditions (p_0, T_0) , the acoustic paths L_1 and L_2 , and their difference ΔL , have
 123 to be corrected using the thermal expansion coefficient α and compressibility coefficient β
 124 of the AISI-316L (namely the material comprising the measuring cell), according to the
 125 following relation:

$$\Delta L(p, T) = \Delta L(p_0, T_0) [1 + \alpha(T - T_0) - \beta/3(p - p_0)]. \quad (4)$$

126 The wide-band ceramic PZT “DuraAct” kapton encapsulated, shown in figure 4 and used
 127 both as the source and the receiver of the acoustic signals, has a diameter of about 10 mm
 128 and is clamped by conical reflectors that reduce its effective radius to about 7 mm without
 129 changing the thickness of the disc; as a matter of fact, the nominal resonant frequency of
 130 8 MHz is not perturbed by this type of clamping, as demonstrated by the long ring down
 131 time shown in figure 2(b).

132 The ultrasonic cell is set in an AISI-316L pressure vessel that can operate in the tempera-
 133 ture range between (240 and 420) K and for pressures up to 300 MPa, sealed with AISI-316L
 134 metallic gaskets. Depending on the pressure range, one of three Honeywell pressure trans-
 135 ducers with full-scale ranges of (10, 50, and 300) MPa was used, while the temperature is

136 measured by means of two PT100 thermometers inserted in the top and the bottom ends of
137 the pressure vessel. These thermometers were calibrated in the range of (230 and 390) K by
138 comparison with INRiM's (Istituto Nazionale di Ricerca Metrologica) Standard Platinum
139 Resistance Thermometer (SPRT) directly traceable to the National Temperature Standard.

140 A liquid bath thermostat maintains the temperature of experiment with a long term
141 stability better than ± 1 mK, over the whole working range, and is composed by a primary
142 external thermostat that can reach a stability of 10 mK and a secondary Proportional
143 Integrative and Derivative control (PID), providing feedback to achieve a finer temperature
144 control.

145 A. Preparation of the apparatus

146 Speed of sound measurements along six isotherms at temperatures of (276.97, 283.15,
147 303.15, 323.15, 343.15, 363.15) K have been carried out. For each isotherm, measurements
148 were taken starting at the pressure of 210 MPa and decreasing the pressure down to low
149 pressure. The high pressure control system has been initially cleaned using volatile solvents
150 and evacuated. Then, the entire high pressure manifold was rinsed with heavy water and
151 subsequently drained and dried by a flow of compressed dry nitrogen several times. The
152 system was then evacuated for 24 h by a trapped mechanical pump, to eliminate any residual
153 trace of fluid and/or air. In order to prevent the possible contamination of the sample and
154 the influence of dissolved gases, the pressure vessel, containing the ultrasonic cell, was filled
155 under vacuum, by extraction of pure deuterium oxide from an ambient pressure reservoir.
156 Successively, the system was filled at the maximum planned pressure, with the purpose of
157 tensioning the main seal of the pressure vessel, while it was immersed in the thermostatic
158 bath. After loading the measuring system with the sample, it was necessary to wait about 8 h
159 to ensure that thermodynamic equilibrium has been reached. Pressure decrements along one
160 isotherm were carried out slowly, taking care not to exceed a decrease rate of 0.1 MPa/s, to
161 preserve the validity of the calibration of the pressure transducers. Following each successive
162 pressure decrease, a temporary cooling of the liquid in the cell of about 10 mK was observed.
163 This temperature change was recovered, by the action of the thermostatic bath, in about
164 one hour. The completion of this transitory phase was observed by continuous monitoring
165 the time-of-flight within the ultrasonic cell and by the temperature readings of the two

Product name:	Deuterium Oxide, 99.9 % D atoms	Molecular Formula:	D ₂ O
Molecular Weight:	20.03	Assay (Quantitative NMR):	99.90 % D atoms
Appearance (color):	colourless	Appearance (form)	Liquid

Table II. Specification of the used sample as reported by the certificate of analysis.

166 thermometers. When measurements on an isotherm were completed, changes of about 10 K
167 were brought to the system in preparation for the next isotherm. In optimal conditions, the
168 thermodynamic equilibrium could be recovered after approximately 12 h.

169 The sample of deuterium oxide (D₂O) was supplied by Sigma-Aldrich. The declared spe-
170 cific mole fraction purity of this sample was better than 99.9 % D atoms. No further analysis
171 or purification was attempted. Some cautions have been taken to try to preserve the purity of
172 the sample. For example, to limit the contamination due to air humidity, bottles have been
173 opened in a climatic room with relative humidity, at ambient temperature, below 20 % and
174 sealed with a valve immediately afterwards. Specification of the used D₂O sample has been
175 reported in table II, as declared by the supplier. Despite taken precautions, density changes
176 have been observed when the sample has been analyzed after speed of sound measurements
177 had been carried out. For this reason, the speed of sound results have been associated to a
178 composition in between the two compositions (99.85 % D atoms) and a further contribution
179 to the uncertainty budget has been added for accounting of the uncertainty of the sample
180 composition.

181 III. SPEED OF SOUND RESULTS AND COMPARISON WITH 182 EQUATION OF STATE PREDICTIONS

183 Speed of sound measurements in heavy water were carried out in the temperature range
184 from (276.97 to 363.15) K and pressures up to 210 MPa. The repeatability of the measure-
185 ments has been checked for the isobar at 100 MPa, resulting in the order of 0.002 %. The
186 relative combined expanded uncertainty ($k = 2$) for the speed of sound measurements was
187 estimated to be between 0.03 % and 0.05 %. Since one of the most important contribution to
188 the speed of sound uncertainty comes from imperfect estimate of the experimental pressure,
189 the budget has been separately prepared to consider a low pressure range with $p < 10$ MPa
190 and a high pressure range with $10 < p/\text{MPa} < 210$ as reported in table III.

Source of uncertainty	Relative uncertainty	Relative uncertainty
	($p < 210$ MPa)	($p < 10$ MPa)
Acoustic path length	0.0065 %	0.006 %
Time-of-flight	0.0010 %	0.001 %
Temperature	0.0070 %	0.007 %
Pressure	0.0197 %	Negligible
Repeatability	0.0020 %	0.002 %
Purity (99.85 % D atoms)	0.0070 %	0.007 %
Overall expanded uncertainty ($k = 2$)	0.051 %	<0.03 %

Table III. Contributions to the **standard** uncertainty of speed of sound measurements **calculated including the corresponding sensitivity coefficients**.

191 Speed of sound measurements have been carried out along six isotherms. The distribution
192 of **the experimental pressure along all these isotherms is not the same**. Table IV lists the
193 **experimental speed of sound** results, while figure 5 and 6 show the corresponding plots, as
194 a function of **pressure and temperature**, respectively.

T / K	p / MPa	$w_{\text{exp}} / \text{m s}^{-1}$
276.97	0.93	1322.00
276.97	2.03	1323.39
276.97	4.01	1326.00
276.97	10.02	1334.18
276.97	30.00	1363.01
276.96	50.04	1394.37
276.97	70.00	1427.23
276.98	99.94	1478.17
276.98	99.95	1478.35
276.97	130.06	1529.92
276.97	160.05	1580.62
276.97	180.07	1614.23
276.98	199.95	1646.91
276.97	209.97	1663.14
277.15	209.95	1663.78
283.16	0.16	1347.86
283.16	10.03	1361.68
283.16	30.01	1391.17
283.15	50.01	1422.20
283.16	69.98	1454.32
283.16	99.98	1503.65
283.16	130.11	1553.42
283.14	159.99	1602.33
283.13	180.08	1634.58
283.15	200.35	1666.55
283.16	210.39	1682.30
303.15	0.21	1412.35
303.15	10.05	1427.41

T / K	p / MPa	$w_{\text{exp}} / \text{m s}^{-1}$
303.15	30.10	1458.55
303.15	49.98	1489.48
303.15	70.07	1520.73
303.15	100.09	1567.31
303.16	129.92	1612.94
303.15	160.09	1658.46
303.16	180.06	1688.03
303.16	190.72	1703.52
303.15	200.11	1717.13
303.15	209.88	1731.26
323.15	0.24	1447.45
323.15	10.07	1463.63
323.15	29.99	1496.13
323.15	50.05	1528.18
323.15	69.96	1559.43
323.15	100.09	1605.79
323.15	130.02	1650.63
323.15	160.06	1694.30
323.15	180.22	1723.07
323.15	200.07	1750.88
323.15	210.16	1764.70
343.15	0.24	1460.86
343.15	10.15	1478.45
343.13	30.08	1512.94
343.14	30.11	1513.02
343.14	50.01	1546.28
343.15	70.09	1578.75
343.15	100.16	1626.01

T / K	p / MPa	$w_{\text{exp}} / \text{m s}^{-1}$
343.15	129.99	1671.09
343.15	160.08	1714.78
343.15	180.27	1743.34
343.15	200.09	1770.97
343.15	209.75	1784.21
363.15	0.24	1457.29
363.15	10.06	1476.36
363.15	29.98	1513.27
363.15	49.91	1548.69
363.14	70.05	1583.21
363.15	100.05	1632.00
363.14	130.06	1678.67
363.14	160.10	1723.09
363.15	180.16	1751.88
363.15	200.12	1779.84
363.15	209.90	1792.96

Table IV: Speed of sound experimental values (w_{exp}) in D₂O as a function of the temperature and pressure. The overall expanded relative uncertainty ($k=2$) of the experimental results is $u(w_{\text{exp}}) = \pm 0.03 \%$ for pressure below 10 MPa and $u(w_{\text{exp}}) = \pm 0.05 \%$ for pressure above 10 MPa.

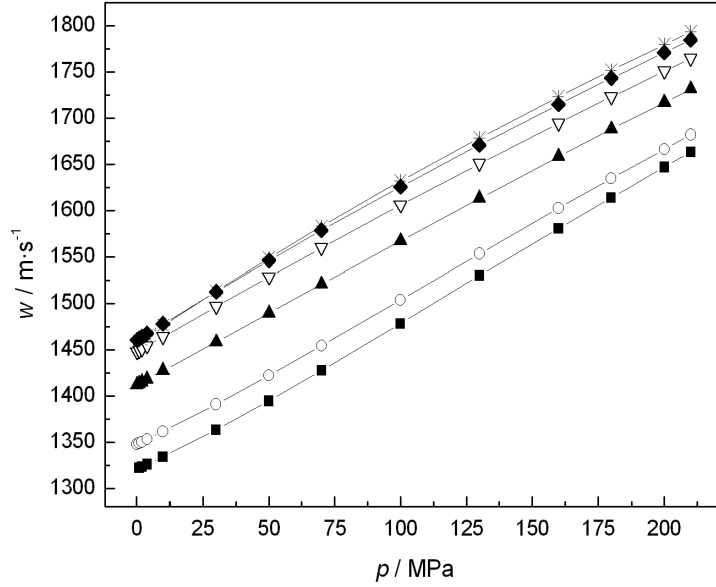

Figure 5. Speed of sound results in deuterium dioxide as a function of pressure. Measurements are affected by an expanded relative uncertainty ($k = 2$) of 0.03 % for pressure up to 10 MPa and 0.05 % at higher pressure. Results are shown by isotherms: (■) 276.97 K; (○) 283.15 K; (▲) 303.15 K; (▽) 323.15 K; (◆) 343.15 K; (*) 363.15 K.

195 Figure 5 shows intersecting isotherms (343.15 K and 363.15 K); this is expected since
 196 the pressure derivative of w significantly varies at low pressure for temperatures higher
 197 than ~ 348 K. The characteristic shift of the speed of sound maximum value towards higher
 198 temperatures, for increasing pressure, is show in figure 6. All the measurements along the
 199 isotherms have been carried out down to a minimum pressure of 0.2 MPa with the exception
 200 of the one at 276.97 K which was limited to 1 MPa.

201 The experimental results obtained in this work were not used to implement the today
 202 most updated fundamental equation of state for heavy water (IAPWS-2017) by Herrig *et*
 203 *al.*¹ and maintained by the International Association for the Properties of Water and Steam.
 204 Considering that the here obtained speed of sound measurements carried out are indepen-
 205 dent from those formulations, the comparison with IAPWS-2017 predictions and with the
 206 previous equation by Hill *et al.*⁶, gives an insight into improvements made by updating the
 207 equation and on whether the most recent can be further improved.

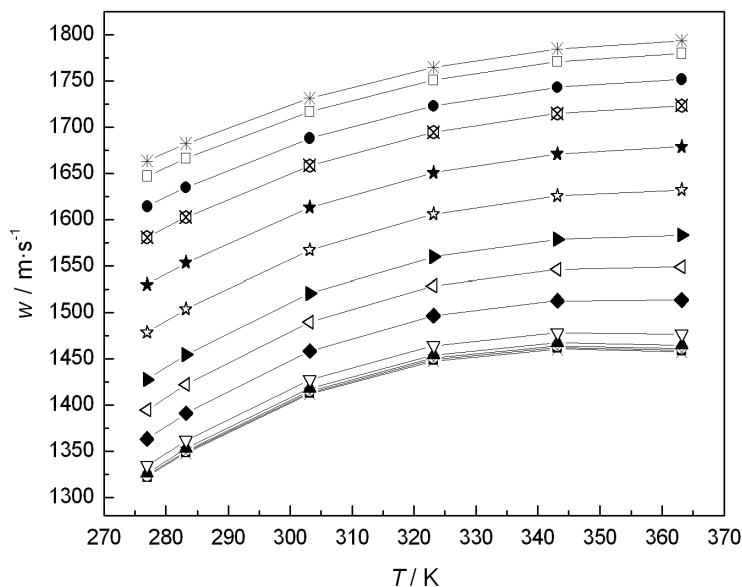

Figure 6. Speed of sound results in deuterium dioxide as a function of temperature. Measurements are affected by an expanded relative uncertainty ($k = 2$) of 0.03 % for pressure up to 10 MPa and 0.05 % at higher pressure. Results are shown by isobars: (\times) 0.1 MPa; (\blacksquare) 1 MPa; (\circ) 2 MPa; (\blacktriangle) 4 MPa; (∇) 10 MPa; (\blacklozenge) 30 MPa; (\triangleleft) 50 MPa; (\blacktriangleright) 70 MPa; (\star) 100 MPa; (\blackstar) 130 MPa; (\otimes) 160 MPa; (\bullet) 180 MPa; (\square) 200 MPa; ($*$) 210 MPa

208 The relative deviations of our speed of sound from the values calculated with the IAPS84
 209 formulation of Hill *et al.*⁶ and with those calculated with a newly developed equation of
 210 state for heavy water by Herrig¹ are illustrated in figures 7 and 8, respectively.

211 For temperatures considered in the present work, the latter equation¹ declares 0.015 %
 212 in the pressure range from (0.1 to 20) MPa, 0.02 % for $20 < p/\text{MPa} < 50$ and 0.1 % for
 213 $50 < p/\text{MPa} < 100$. For pressure above 100 MPa the uncertainty has not been declared since
 214 speed of sound values were obtained by predictions not validated by experimental results.
 215 Comparing the plots in figure 7 and 8, it is apparent that the most recent equation¹ performs
 216 significantly better than the previous one. For example, the maximum relative deviations
 217 decrease from 1 % to 0.1 % for pressure up to 100 MPa. Furthermore, as reported in figure 9,
 218 when pressures below 100 MPa are considered, deviations from the equation of state¹ are
 219 well within 0.07 %.

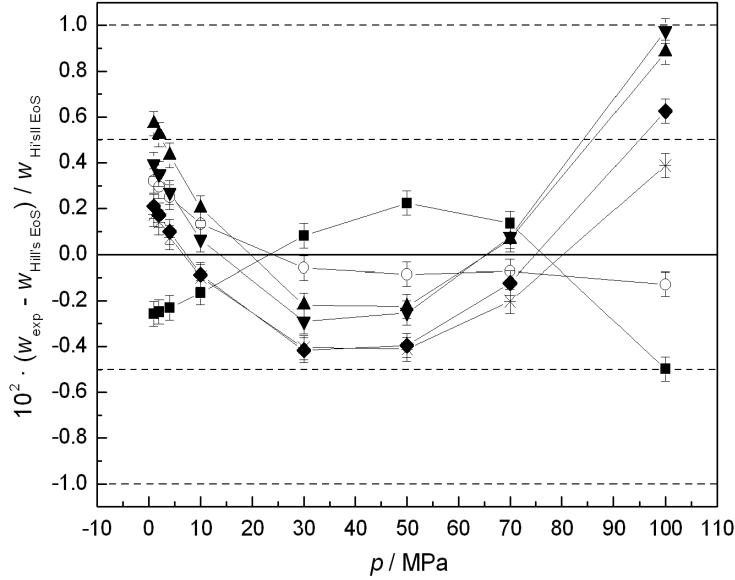

Figure 7. Relative deviation of experimental speed of sound results from Hill's equation of state. This equation has a declared relative uncertainty on speed of sound predictions of 1 % for temperature up to 350 K and 0.5 % above. Symbols correspond to (■) 297.97 K; (○) 283.15 K; (▲) 303.15 K; (▼) 323.15 K; (◆) 343.15 K; (*) 363.15 K. Reported results are affected by an expanded relative uncertainty ($k = 2$) of 0.03 % for pressure to 10 MPa and 0.05 % at higher pressure.

220 For pressure below 20 MPa, very accurate speed of sound measurements are available from
 221 Wegge *et al.*⁵ with a declared uncertainty of 0.015 %. That experiment was carried out using
 222 a measurement cell with different lengths of the spacers, a different carrier frequency and a
 223 different piezoelectric source, both in terms of materials and dimensions, so that obtained
 224 results can be considered as independent. In Wegge *et al.*⁵, nominal spacers lengths were
 225 (20 and 30) mm and a 15 mm diameter X-cut quartz crystal was used as an ultrasonic
 226 source when excited by 30-cycles sinusoidal burst with a carrier frequency of 8 MHz. Quartz
 227 crystals can operate up to temperature higher than those of ceramic piezoelectric disks
 228 adopted in this work. Anyway, considering the maximum temperature here investigated,
 229 both the materials are equivalent. Differences are more evident considering the band-width
 230 and the sensitivity of the two different sources. Quartz crystals have a lower sensitivity, so

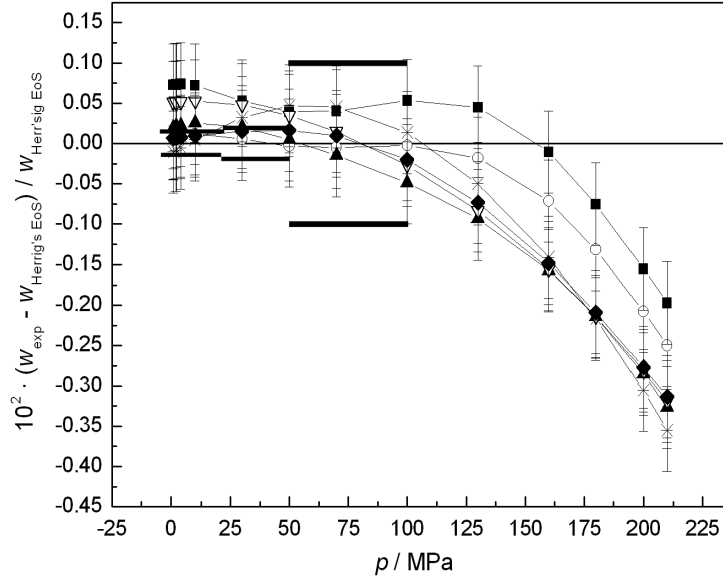

Figure 8. Relative deviation of experimental speed of sound measurements from Herrig's EoS. Reported results are affected by an expanded relative uncertainty ($k = 2$) of 0.03 % for pressure up to 10 MPa and 0.05 % at higher pressure. Symbols correspond to (■) 297.97 K; (○) 283.15 K; (▲) 303.15 K; (▽) 323.15 K; (◆) 343.15 K; (*) 363.15 K.

231 they need to be excited by a higher number of cycles (30 in that case), before reaching their
 232 maximum oscillation amplitude. Here adopted wide-band encapsulated ceramic disk can
 233 reach maximum amplitude oscillation after just three cycles. The quartz crystal intrinsic
 234 narrow band has the side effect of generating much more oscillations with respect to those
 235 used to excite the source. For wide-band sources, working out of their resonant frequency,
 236 only a couple of extra cycles are recorded by the digital oscilloscope. Considering the frame
 237 of the measurements reported in this work, both the sources perform at the same level since
 238 in both cases the time-of-flight is measured with a relative uncertainty below 20 part per
 239 million. The better accuracy obtained by Wegge *et al.* comes from a better measurement
 240 of the temperature and the pressure, since they have used a Standard Platinum Resistance
 241 Thermometers and a pressure transducer with a better accuracy.

242 From figure 10, which illustrates a comparison between the results obtained here and
 243 those of Wegge *et al.*, it is possible to observe a significant negative relative deviation.

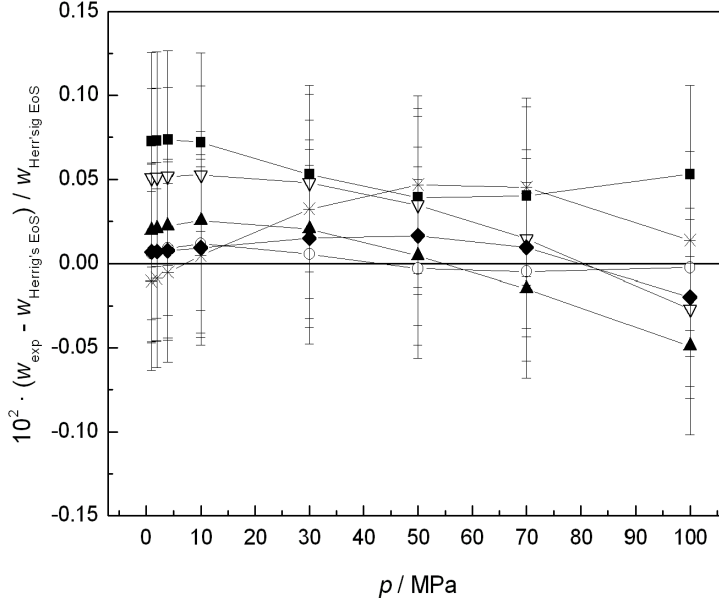

Figure 9. Relative deviation of experimental speed of sound results from Herrig’s EoS limited in pressure to 100 MPa. Symbols belong to (■) 297.97 K; (○) 283.15 K; (▲) 303.15 K; (▽) 323.15 K; (◆) 343.15 K; (*) 363.15 K.

244 A possible explanation for the systematic deviation of these two measurements sets can
 245 possibly ascribed to a different purity of the sample because the heavy water used in Wegge
 246 *et al.* was pure at 99.995 % D atoms, while the purity of the sample used in this work was
 247 only 99.85 % D atoms. Despite this significant purity difference, speed of sound results of this
 248 work are still consistent with those of Wegge *et al.*, considering their combined uncertainties.
 249 The only isotherm showing a significant deviation is that at the lowest temperature where,
 250 probably, the effect of the contamination is enhanced by proximity to the freezing curve.

251 IV. CONCLUSION

252 In this work, we report more than seventy experimental speed of sound measurements
 253 in heavy water (deuterium oxide, D₂O; purity: 99.85 %) on six isotherms between (276.97
 254 and 363.15) K and, for the first time, for pressure up to 210 MPa. The results have been
 255 obtained using the double *pulse-echo* technique and their estimated expanded relative com-
 256 bined uncertainty ($k = 2$) is, over the whole temperature range, in the order of 0.05 % for

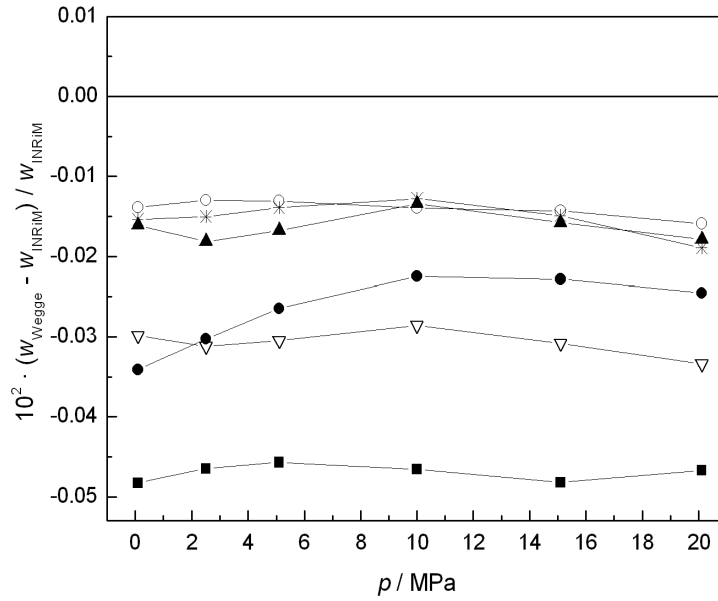

Figure 10. Comparison with the experimental speed of sound results of Wegge *et al.*⁵ as a function of the pressure. Results are shown by isotherms: (■) 278.21 K; (○) 283.20 K; (▲) 293.20 K; (▽) 310.20 K; (●) 333.20 K; (*) 353.20 K.

257 pressures above 10 MPa and of 0.03 % for pressures below 10 MPa. The obtained speed of
 258 sound values have been compared with the predictions of the reference equation for heavy
 259 water (IAPS84 Formulation) by Hill *et al.* (1982) and with those calculated from the newly
 260 developed EoS for heavy water by Herrig *et al.* (2018), with resulting relative deviations
 261 [that are always less than](#) the combined uncertainties. The speed of sound results have been
 262 compared with the most recent [results](#) of Wegge *et al.* finding a remarkable agreement
 263 within the declared uncertainty (better than 0.05 %).

264 [Future work is planned to extend speed of sound measurements in deuterium oxide at](#)
 265 [temperatures lower than the triple-point and for pressure up to 300 MPa. When available,](#)
 266 [these results will be useful to update the recent dedicated EoS developed by Herrig *et al.*](#)
 267 [\(2018\).](#)

268 ACKNOWLEDGMENTS

269 The authors do thank Stefan Herrig for kindly sharing data and information about his
270 work before publication. Furthermore, the authors would like to thank the International As-
271 sociation for Properties of Water and Steam for the collaboration and for giving suggestions
272 and ideas for this and future works.

273 REFERENCES

- 274 ¹S. Herrig, M. Thol, A. H. Harvey, E. W. Lemmon, “A Reference Equation of State for
275 Heavy Water”, *Journal of Physical and Chemical Reference Data* 47(4), [043102](#) (2018).
- 276 ²W. D. Wilson, “Speed of sound in heavy water as a function of temperature and pressure”,
277 *The Journal of Acoustical Society of America* 33, 314 (1961).
- 278 ³C. T. Chen, F. Millero, “Speed of sound in deuterium oxide relative to normal water as a
279 function of temperature and pressure”, *The Journal of Acoustical Society of America* 62,
280 553 (1977).
- 281 ⁴A. A. Aleksandrov, D. K. Larkin, “Experimental speed of sound in heavy water in the wide
282 temperature and pressure ranges”, *Teploenergetika* 24(1) pp 73-75 (1977).
- 283 ⁵R. Wegge, M. Richter, R. Span, “Speed of sound measurements in deuterium oxide (D₂O)
284 over the temperature range from (278.2 to 353.2) K at pressures up to 20 MPa”, *Fluid
285 Phase Equilibria*, 418, [175-180](#) (2016).
- 286 ⁶P.G. Hill, R.D. Chris MacMillan, V. Lee, “A Fundamental Equation of State for Heavy
287 Water”, *Journal of Physical and Chemical Reference Data* 11(1), [1-14](#) (1982).
- 288 ⁷G. Benedetto, R.M. Gavioso, P.A. Giuliano Albo, S. Lago, D. Madonna Ripa, R. Spagnolo,
289 “Speed of sound in pure water at temperature between 274 and 394 K and pressures up to
290 90 MPa”, *International Journal of Thermophysics* 26, 1667 (2005).
- 291 ⁸W. Wagner, A. Pruß, “The IAPWS formulation 1995 for thermodynamic properties of
292 ordinary water substance for general and scientific use”, *Journal of Chemical Physics and
293 Reference Data* 31, [387-535](#) (2002).
- 294 ⁹S. Lago, P. A. Giuliano Albo, D. Madonna Ripa, “Speed of sound measurements in n-
295 Nonane at temperatures between 293.15 and 392.15 K and pressures up to 100 MPa”,
296 *International Journal of Thermophysics* 27(4), 1083 (2006).

297 ¹⁰S. Lago, P. A. Giuliano Albo, J. S. Brown, “Compressed liquid speed of sound measure-
298 ments of cis-1,3,3,3-tetrafluoruroprop-1-ene (R1234ze(Z)), International Journal of Refrig-
299 eration 65, 55 (2006).