



ISTITUTO NAZIONALE DI RICERCA METROLOGICA Repository Istituzionale

Power Quality Assessment in Railway Traction Supply Systems

Original

Power Quality Assessment in Railway Traction Supply Systems / Femine, Antonio Delle; Gallo, Daniele; Giordano, Domenico; Landi, Carmine; Luiso, Mario; Signorino, Davide. - In: IEEE TRANSACTIONS ON INSTRUMENTATION AND MEASUREMENT. - ISSN 0018-9456. - 69:5(2020), pp. 2355-2366. [10.1109/TIM.2020.2967162]

Availability:

This version is available at: 11696/66565 since: 2021-02-05T16:22:47Z

Publisher:

IEEE-INST ELECTRICAL ELECTRONICS ENGINEERS INC

Published

DOI:10.1109/TIM.2020.2967162

Terms of use:

This article is made available under terms and conditions as specified in the corresponding bibliographic description in the repository

Publisher copyright

(Article begins on next page)

Power Quality Assessment in Railway Traction Supply Systems

Antonio Delle Femine¹, Member, IEEE, Daniele Gallo², Member, IEEE, Domenico Giordano³, Carmine Landi⁴, Senior Member, IEEE, Mario Luiso⁵, Member, IEEE, and Davide Signorino⁶, Student Member, IEEE

Abstract—The assessment of the power quality (PQ) could be a valuable tool to foster the efficiency of the railway systems. PQ is a well-addressed topic in conventional ac 50/60 Hz power systems, and many procedures, algorithms and measurement systems were presented in the international standards and widely discussed in the scientific literature. A less explored research field is the assessment of the PQ in the railway traction supply systems, in particular with reference to the dc and 16.7 Hz systems. The article explores this theme, proposing an extension of the definitions and of the standard measurement procedures for some of the main PQ indexes, well defined and widely used for conventional power systems, in order to be used also in all railway traction supply systems. The limits or difficulties of applicability are discussed with reference to measurements performed both on-board and in substation. The proposed procedures are applied to an experimental case of a real dc railway system with a large measurement campaign.

Index Terms—Current measurement, dc power quality (PQ), power system measurements, PQ measurements, railway system, voltage measurement.

I. INTRODUCTION

IN THE railway systems, the electrical locomotives are big single-phase loads for the traction supply system. As the speed and mechanical conditions of the train change frequently, they appear nonlinear and time-varying loads, injecting a certain number of conducted electrical disturbances that propagate on the supply line, even reaching other trains or even the power substation, [1]–[3]. On the other hand, the electrical substations absorb energy from the high-voltage ac grid to feed the locomotives at a lower voltage level. Obviously, many of the power quality (PQ) problems in the

high-voltage ac network are transferred to the rail traction supply system (RTS). In addition, also an ac/dc conversion is required in dc RTS and this generates a voltage ripple at dc side due to harmonics of ac power frequency [4].

The assessment of the PQ could be a valuable tool to foster the efficiency of the whole railway system by “awarding” the good PQ delivered and absorbed. In fact, there is a great interest in the research community and in the stakeholders in developing and applying the PQ concepts also to railway systems [4]–[9].

Despite of this interest on the generated or suffered conducted disturbances (f.i. voltage dips/swells, voltage fluctuations, voltage and current harmonics, etc.), few researches address the PQ issues in RTS. Only the international standard [10], by specifying the main characteristics of the supply voltages of RTSs, introduces some definitions for PQ events. However, there are only few vague references to the measurement methodology. There are some standards, [11], [12], and the Italian national compatibility or interoperability procedures, [13], that fix the methods for the testing of a rolling stock before the entry into service. These technical specifications provide reference behaviors of locomotive in the presence of some PQ events (such as voltage dips) and limits for current spectral components in order to guarantee the compatibility with the communication systems. As a consequence, there is a lack of international standards that univocally define the PQ indexes, the measuring procedures and the corresponding compatibility and immunity thresholds, with specific reference to the RTSs. For ac 50/60 Hz RTSs, some benefits can come from the sound tradition in PQ measurements developed for other ac power systems that are covered by comprehensive standards [14], [15]. However, these standards are not always directly applicable to the RTS, as it will be shown in the following. The situation is much worse for dc and 16.7 Hz RTSs. There are only few proposals for the definition of PQ indexes and measurement techniques [4], [16]–[18] for dc supply systems, but it is still an open issue.

The work presented in this article is inserted in the context of the European project [19]. One of the objectives of this project is to develop a metrological framework for calibration to enable high-accuracy energy and PQ measurements in the RTSs. To this aim, this article, starting from the discussion made in [17], analyzes and discusses the applicability of the

Manuscript received August 7, 2019; revised December 19, 2019; accepted January 3, 2020. Date of publication January 1, 2020; date of current version April 7, 2020. The results here presented are developed in the framework of the 16ENG04 MyRailS Project that received funding from the EMPIR programme co-financed by the Participating States and from the European Union’s Horizon 2020 Research and Innovation Programme. The Associate Editor coordinating the review process was Dr. Roberto Ferrero. (Corresponding author: Mario Luiso.)

Antonio Delle Femine, Daniele Gallo, Carmine Landi, and Mario Luiso are with the Department of Engineering, University of Campania “Luigi Vanvitelli,” 81031 Aversa (CE), Italy (e-mail: antonio.dellefemine@unicampania.it; daniele.gallo@unicampania.it; carmine.landi@unicampania.it; mario.luiso@unicampania.it).

Domenico Giordano and Davide Signorino are with the Istituto Nazionale di Ricerca Metrologica (INRIM), 10135 Torino, Italy (e-mail: d.giordano@inrim.it; d.signorino@inrim.it).

Color versions of one or more of the figures in this article are available online at <http://ieeexplore.ieee.org>.

Digital Object Identifier 10.1109/TIM.2020.2967162

measurement procedures of some of the main PQ indexes, well defined and widely used for conventional power systems (interruptions, voltage dips/swells, harmonics and transitory voltage). Moreover, it proposes an extension of these PQ indexes and measurement algorithms to allow their applicability to all RTSs (ac 50/60 Hz, ac 16.7 Hz and the dc). Then, the proposed techniques are applied, as experimental case study, to a real dc RTS during a large measurement campaign.

This article is organized as follows. Section II shows a brief description of the main RTSs. Section III is focused on the applicability of some standard PQ measuring procedures to RTS. Section IV presents some PQ indexes, identifying the limitations in their applicability and proposing some extensions. In Section V, the experimental results from a comprehensive measurement campaign are reported. Finally, in Section VI the conclusions are drawn.

II. RAILWAY SUPPLY POWER SYSTEMS

The energy, transformed or generated by power substations, is supplied to moving trains with a (nearly) continuous transmission line running along the track. As for the technologies adopted for the transmission of power, there is a wide variety of solutions still adopted, both in dc or ac (see [2, Table1], [17]). The most significant electrical systems are the following:

- 1) 750/1500/3000 V in dc;
- 2) 15 kV in ac at 16.7 Hz;
- 3) 25 kV in ac at 50/60 Hz.

A. DC System

Fig. 1 shows a sketch of a typical dc supply system. The key feature of this system is a rectifier for converting alternating current to direct current. Typically, a three-phase rectifier system with six-pulse is used; this introduces harmonics in the ac side and distortion in the dc voltage. To reduce the harmonics, a more-modern rectifier design using a 12-pulse system featuring two sets of six-pulse rectifying circuits, with ac input voltage phases 30° apart, connected in series or parallel, is used. In both cases, the adoption of a filtering system can improve the PQ level.

Normally, each track is fed in each direction towards the next substation. The distance between substations is about 5 km on metropolitan trunk lines and 10–20 km on other lines. Gaps in supply lines are located in the substations and in sectioning posts for obtaining a separation between zones fed from different substations. Gaps can be closed when a substation fails. This allows a redundant supply and guarantees the continuity of service.

B. AC Systems

In Fig. 2, there is a simplified diagram showing an ac RTS. Since three-phase power from the utility is converted into two single phases, to obtain better load balancing in the three supply lines, a separate phase feeds each of the up and down tracks. Overhead lines are normally fed in sections, like dc RTSs, but ac overhead sections are usually much longer.

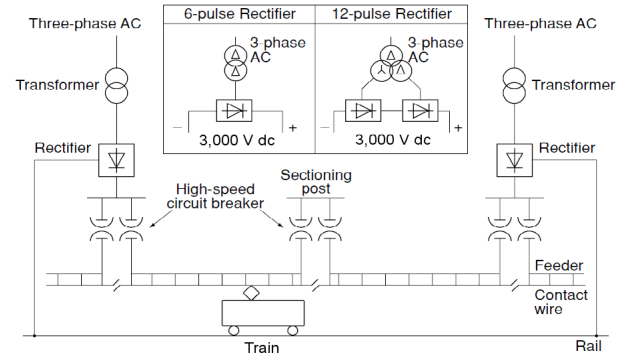

Fig. 1. Railway dc supply system [2].

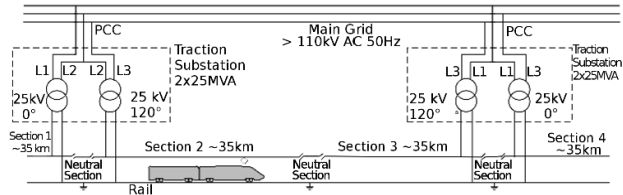

Fig. 2. Railway ac supply system [2].

The distance between substations is in the range 20–40 km. Each subsection is isolated from its neighbor by a neutral section (Fig. 2) that is a line without supply of about 110 m. In fact, it is important that the train does not connect two different supplies by passing over the gap, as they are from different phases. In addition, to reduce the arcing at a neutral section in the overhead catenary, some systems use track magnets to automatically switch off the power on the train on the approach to the neutral section. A second set of magnets restores the power immediately after the neutral section has been passed. If a substation fails, the subsections can be joined through special high-speed switches.

III. STANDARD PQ MEASURING PROCEDURE

There is a wide interest on the conducted disturbances in RTS (f.i. voltage dips/swells, voltage fluctuations, spectral distortions, etc.). Nevertheless, as previously mentioned, there is a lack of international standards that univocally define PQ indexes, measuring procedures and the corresponding compatibility and immunity thresholds, with specific reference to the RTS. Obviously, the first attempt, before starting to define new specific PQ indexes or measurement procedures, is to verify the applicability, at least for 50/60 Hz RTSs, of definitions and procedures already established for other power supply systems. To this end, the next sections will refer to the IEC 61000 family standards [14], [15], discussing some of the main aspects of PQ-measuring procedures, identifying problems and limitations of their applicability to ac RTS. The discussion is conducted in order to propose an extension with minimal changes of the standard procedures to other RTS (dc and 16.7 Hz).

A. Measurement Aggregation Time

The continuous monitoring of PQ indexes leads rapidly to unmanageable amount of data. For practical reason,

several sequential values of a given parameter are combined (each determined over identical time intervals) to provide average values for longer time intervals.

In [14], the basic measurement time interval prescribed for measurements of quasi-stationary PQ index (magnitude of the supply voltage, harmonics and interharmonics pollutions and unbalance) is about 200 ms (exactly 10 cycles of 50 Hz and 12 cycles of 60 Hz). The 10/12-cycle values are then aggregated over two main intervals: about 3 s (150/180 cycles for 50/60 Hz), and exactly 10-min interval of absolute time. The 10/12-cycle measurement has to be resynchronized at every UTC (Universal Time Coordinated) 10-min tick with a partial overlapping of measurement data.

This approach can obviously be directly applied at 50/60 Hz ac RTS, but it would be desirable to select analog time intervals also for all other RTSs. In dc, the same time intervals (200 ms, 3 s, and 10 min) can be adopted, defining them with reference to the absolute time. Some difficulties arise in the 16.7 Hz ac RTS, whereas in 200 ms there are 3.34 cycles. In order to reach an integer number of cycles, the time intervals should be defined as about 180 ms (exactly 3 cycles) and about 3 s (50 cycles) and exactly 10 min. For simplicity, the measurement time intervals, here exactly defined, will be briefly indicated hereinafter as “200-ms” and “3-s” time intervals for all RTSs.

The previously described measurement method, used for quasi-stationary signals, is not suitable for the detection and measurement of nonstationary disturbances: voltage dips, swells, interruptions and transients. Reference [14] states that voltage dips, swells and interruptions should be obtained by measuring the voltage root mean square (rms) value over 1 cycle, starting at a fundamental zero crossing, and refreshing every half-cycle; this quantity is called $U_{\text{rms}}(1/2)$. The same approach can be applied for the 16.7 Hz and dc RTSs. One cycle of 16.7-Hz RTS and 10 ms for dc RTS can be used as references. It can be noticed that the interval of 10 ms is also the minimum event duration accounted in [10].

For simplicity, the supply voltage measured as exactly defined here will be briefly indicated hereinafter as “basic supply level” for all RTSs.

B. PQ-Monitoring Location

Generally speaking, the choice of the locations on which to install PQ monitor devices is dependent upon the objective of the survey. If the monitoring objective is to diagnose an equipment performance problem, then the monitor should be placed as close as possible to the load. In conventional ac power systems, this applies to performance problems with both sensitive electronic loads (such as computers and adjustable speed drives, etc.) and electrical distribution equipment (such as Circuit Breakers (CB), capacitors, etc.). For compliance monitoring related to service contracts, the monitoring location should be at the point of common coupling between the customer and the system. Translating this approach to RTS, with the same objective, the monitoring of PQ indexes can take place in two main locations, giving different information from different points of view: on-board train and in the supply substations.

The measurements on-board train keep track of PQ issues that the specific monitored train has faced during its journey, tapping power from different substations along its route. Monitoring a supply line within a substation gives information about problems of a specific supply site of a railway track, in different moments of the day and in different days of the week, which feeds different trains that pass through there. Both are interesting points of view. The first is mainly of interest of the train owner, the second is of interest of infrastructural manager. The two installation locations have very different impacts in terms of applicability of the techniques of the PQ measurements.

With reference to 50/60 Hz systems, PQ monitoring in substations is quite similar to monitoring any power system with the peculiarity of having a few very big and time-varying loads, so that even a commercial PQ-monitoring instrument can be installed and profitably used. In this case, detection thresholds (f.i. for dip/swell) should be set, accounting the particular system as discussed in the following. On-board monitoring is much more complicated due to the structure of the supply system. In fact, in 50/60 Hz RTS, due to dead neutral sections (see Fig. 2), in normal working conditions, the supply is periodically disconnected every few minutes (with a speed of 100 km/h, the distance of 10 km is covered in 6 min). A PQ-monitoring device sees these events as periodic short interruptions (with a speed of 100 km/h, the length of neutral section of 110 m is passed in about 4 s). Obviously, an interruption remarkably affects the calculation of all other PQ parameters. For this reason, [14] introduces the flagging concept: during a dip, swell or interruption, the measurement algorithm of the other PQ parameters might produce an unreliable value. The flagging avoids multiple counting of a single event in different parameters (for example, counting a single voltage dip both as a dip and a frequency variation) and indicates that an aggregated value might be unreliable. If during a given time interval any value is flagged, the aggregated value (i.e., at 3 s or 10 min) which includes that value shall also be flagged. With the described timing, in 50/60 Hz RTS, all the 10-min values would be unreliable. Anyway, it is possible to refer to 3-s values: only few of these time intervals are flagged due to passing through the neutral section.

For dc and 16.7 Hz RTSs, instead, commercial PQ-monitoring systems and standard measuring procedures are not directly applicable, as their working lays on the synchronization with a 50/60 Hz signal, which is missing in both cases. In addition, even with specialized monitoring devices, in 16.7 Hz RTSs, the same issues, due to neutral sections previously described, would arise for on-board monitoring. dc RTS, instead, has not this problem, as the supply technology allows to switch between two consecutive feeders without discontinuity.

IV. ANALYSIS AND DISCUSSION OF PQ INDEXES

In the following, some of the main PQ indexes are discussed in terms of their applicability to RTS monitoring. For the definition and the measurement procedure, reference was made to standards [14], [15].

A. Magnitude of the Supply Voltage

The first task of a PQ monitoring is the assessment of the supply voltage magnitude (rms. for ac and mean values for dc) during different datetimes and different days, when no other PQ event applies. The statistical analysis of magnitude measured over “200 ms” (e.g., 95% probability weekly values, expressed in volt) gives information about the level of stress of all the devices supplied and it can be used for predictive maintenance purposes.

B. Voltage Interruption

A voltage interruption applies when “basic supply level” falls below a certain threshold (i.e., 1% of nominal amplitude for [10]) for a certain time. The characterizing parameter of the phenomenon is the duration.

The monitoring of this PQ phenomenon can be performed in the substations of all the RTS, without particular attention. On the contrary, in ac RTSSs, monitoring on-board is not a trivial task, because of the normal and periodic interruption that train supply has, due to neutral or dead sections. In fact, the time spent to pass the neutral section is about 1.3 s at 300 km/h and about 10 s at 40 km/h. Therefore, for interruptions of duration in the range 1–10 s, it is very difficult to distinguish a true PQ phenomenon from normal interruptions due to the neutral sections. Additional information could help (train position and speed), but it is practically impossible to monitor properly this kind of interruptions. For durations less than 1 s and longer than 10 s, interruptions can be correctly detected and univocally associated with PQ events. The accuracy in the duration measurement is limited at half cycle due to the synchronization with the zero crossing prescribed by the standard [21]. Obviously, the accuracy is worse in the 16.7 Hz system. Algorithms with a higher resolution were already proposed [18], [20] and a better estimate can be obtained if a new amplitude value is calculated every new sample acquired.

Another important aspect to consider in all the RTSSs is that the electric trains have a main CB to isolate the power supply, interrupting current flow, within some milliseconds, so they are also called extra-rapid. These CBs can be opened by the train control unit (TCU) for several reasons, including over-currents, over-voltages, under-voltages, detection values above the maximum limit but also over-heating of the traction motors, railway signaling, generic anomaly detected by the TCU, and so on. Therefore, many PQ events evolve into interruptions but, at the same time, interruptions may not be caused by PQ events. Monitoring voltage before CB avoids considering abnormal conditions as PQ events.

C. Voltage Dip and Swell

A voltage dip/swell begins when the “basic supply level” falls/rises below/above a certain threshold and ends when the voltage rises/falls above/below the dip/swell threshold plus the hysteresis voltage. The purpose of this hysteresis is to avoid counting multiple events when the magnitude of the parameter oscillates about the threshold level. The suggested hysteresis in [14] is 2% of the nominal voltage.

TABLE I
NOMINAL VOLTAGE AND THEIR PERMISSIBLE LIMITS

Electricification system	Lowest non-permanent voltage	Lowest permanent voltage	Nominal voltage	Highest permanent voltage	Highest non-permanent voltage
Symbol	U_{min2}	U_{min1}	U_n	U_{max1}	U_{max2}
Unit	[V]	[V]	[V]	[V]	[V]
DC (mean values)	500 1.000 2.000	500 1.000 2.000	750 1.500 3.000	900 1.800 3.600	1.000 1.950 3.900
AC (r.m.s. values)	11.000 17.500	12.000 19.000	15.000 ^a 25.000 ^b	17.250 27.500	18.000 29.000
a) 16,7 Hz. b) 50 Hz and 60 Hz.					

The dips/swells are characterized by measuring the duration and the minimum/maximum voltage magnitude during the event. In [14], the adopted thresholds are 90% and 110% of the nominal amplitude, respectively, but these values are not acceptable for the RTS. In fact, the nominal voltage and its permissible limits, according to [10], are reported in Table I, along with the following indications.

- 1) Under normal operating conditions, voltages shall lie within the range $[U_{min1}, U_{max2}]$.
- 2) Under abnormal operating conditions the voltages in the range $[U_{min2}, U_{min1}]$ shall not cause any failures.
- 3) The duration of voltages between U_{min1} and U_{min2} shall not exceed 2 min.
- 4) The duration of voltages between U_{max1} and U_{max2} shall not exceed 5 min.
- 5) The voltage at the substation busbar, at no load condition, shall be less than or equal to U_{max1} . For dc substations, it is acceptable to have the busbar voltage at no load condition higher than U_{max1} and less than or equal to U_{max2} , provided that when a train is present, the voltage at this train pantograph(s) is in accordance with Table I and its requirements.
- 6) Voltages between U_{max1} and U_{max2} shall only be reached for nonpermanent conditions, such as regenerative braking or during commutation of voltage regulation systems (e.g., mechanical tap changers).
- 7) Lowest operational voltage: under abnormal operating conditions U_{min2} is the lowest limit of the contact line voltage for which the rolling stock is intended to operate.
- 8) Recommended set values for undervoltage tripping relays in fixed installations or on-board rolling stock are from 85% to 95% of U_{min2} .

It is apparent from these requirements that the supply voltage is expected to be much less stable than in the normal power system. Therefore, tight detection thresholds (i.e. $\pm 10\%$) would result in continuous useless event detections. These large variations are allowed as the power absorbed by trains is not negligible with respect to the short circuit power of substations and so it is usual that remarkable voltage drops apply when one or more trains require a considerable amount of power.

Moreover, with the described indications, the detection and classification of dip/swell are much more complicated, as, in general, it is necessary to manage the comparison with four thresholds and measuring different time intervals for different threshold crossings. Limit assessment requires information also on the presence of trains in substation and on the braking state. With minor modifications of the definition, as already done for interruption, these parameters can be monitored in the substations of all the RTSs.

For swell detection, reference should be made to the over-coming of $U_{\max 1}$ of Table I.

In RTS substation, it is a common practice to have the set point for line voltage greater than $U_{\max 1}$ with the limit reported in previous point e). This implies that, simply referring to $U_{\max 1}$, during a stop in a station, a train experienced a swell if there is not another train passing on the same feeder and, at the same time. Moreover, a PQ monitor in a substation found a huge number of swell events.

During train braking, the control system tries to recover energy, injecting current on the feeder, but this is possible without problems only when there are other trains able to absorb this current on the same feeder. If there are no other trains that use the energy in that specific moment, the voltage can rise, exceeding $U_{\max 2}$, and so the regenerative braking must be limited. To this aim, the trains are equipped with an automatic limiting function that switches the current flow to braking rheostats, wasting the regenerated energy when voltage goes over $U_{\max 2}$ limit. This design choice fosters the continuity of service but limits the energy recovering during braking. Consequently, most braking cause a swell but this should be accounted as a normal working condition. However, values over $U_{\max 2}$ should be always considered as an important PQ event.

D. Distortion of Voltage and Current

In [15], the distortion is evaluated by Fourier series expansion: each group of M samples forms a time window on which DFT is performed; the window width T_N determines the frequency resolution $f_C = 1/T_N$ (i.e., the frequency separation of the spectral components) obtained in the analysis. Therefore, the window width T_N must be an integer multiple N of the fundamental period T_1 of the system voltage: $T_N = N \times T_1$. The sampling rate is in this case $f_s = M/(NT_1)$ (where M = the number of samples within T_N). The adopted window width is 10/12 (50/60 Hz systems) fundamental periods ($T_N \approx 200$ ms in both cases). To improve the assessment accuracy, the obtained spectral components are grouped obtaining reliable pollution indexes (harmonic and interharmonic subgroups) and deriving cumulative pollution index: THD, THDG [15]. The basic frequency ranges for measurement include components in signals (currents or voltages) up to the 40th harmonic order (approximately 2 kHz).

Obviously, the same approach can be used in motoring RTS at 50/60 Hz. Normal periodic disconnections, due to the neutral sections, prevent the adoption of an aggregation time interval longer than 3 s. Moreover, a flagging procedure has

to be adopted to avoid calculating distortion in unstationary conditions.

In 16.7 Hz RTSs, this procedure can be applied with minor changes: the number of analyzed cycles should be 3 ($T_N \approx 180$ ms). On this basis, harmonic subgroups and the consequent THD index can be properly calculated. Only the interharmonic pollution cannot be evaluated. In fact, due to the reduced number of periods adopted, the interharmonic components are no more calculable. In order to calculate also interharmonics, time window should be enlarged till ten periods ($T_N \approx 600$ ms), but this would result in a reduced time resolution for fast transitory harmonic events.

In dc RTSs, there is no basic periodicity to consider; so it is meaningless to talk about harmonic and interharmonic pollution. Nevertheless, it could be useful to refer, also in this case, to 200 ms for time window. Therefore, it is possible to obtain components, groups and comprehensive indexes in a similar way to that adopted in other systems. However, in this case, it is more appropriate to speak generically about spectral pollution, including all the components. To this aim, as an extension of THD (defined in [15]), an index of total spectral distortion (TSD) can be defined as the ratio between the rms. value of the sum of all the spectral components (Y_h), up to a specified frequency index (h_{\max}), and the reference value (Y_{ref}):

$$\text{TSD}_Y = \sqrt{\sum_{h=1}^{h_{\max}} \left(\frac{Y_h}{Y_{\text{ref}}} \right)^2} \quad (1)$$

where the symbol Y should be replaced, as required, by the symbol I for currents or by the symbol U for voltages. The nominal value of voltage or current should be adopted as the reference value, to avoid excessive fluctuation in the index value generated by the remarkable variability of the dc mean values.

Although there is no basic periodicity, even in dc system it is useful to have a specific index to monitor separately the pollution around 50 Hz. In fact, the presence of this component is particularly feared by the managers of the dc railway system as it directly affects signaling systems. For this reason, there is already present a specific monitoring device that alarms and disconnects the system when the level of 50 Hz spectral component reaches a prescribed limit level. To this aim, Eq. (1) should be modified to include only spectral components that are located at frequencies near to the multiples of 50 Hz. For formal definition, reference should be made to harmonic subgroups reported in [15].

For all the RTS, a not trivial task is to define the compatibility/immunity thresholds. However, there are already some amplitude levels for harmonic currents defined to ensure compatibility. Traditionally, the vehicle shall not exceed certain limits of harmonic current versus frequency (harmonic envelope). The harmonic envelope is normally defined with respect to signaling equipment [12], [13].

E. Transitory Voltage

The transitory voltages in the RTSs are very often due to the nonnegligible power required by trains with respect

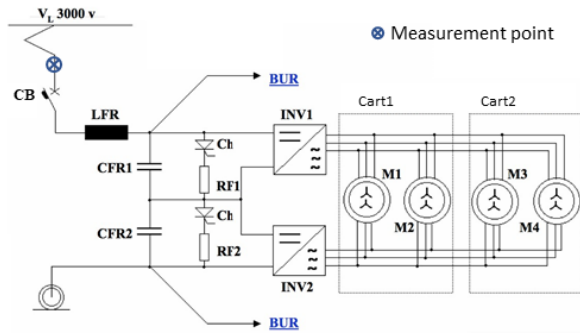

Fig. 3. E464 schematic of power supply system.

to nominal power of substations. Therefore, transients can come from sudden changes in traction load, configurations of traction power supply network, configurations of the main or railway power supply network. If they are within the ranges set up in Table I, they should be considered normal working conditions.

Voltage values that go beyond the $U_{\max 2}$ can cause problems and should be detected and recorded as PQ events. For their detection, a sample-by-sample analysis should be adopted. A specific event that can affect the quality of RTS is the electrical arc that can occur between the pantograph and the overhead line due to partial detachments of the two electrodes of the sliding contact. One of such electric arcs produces a transitory event on both voltage and current. For their detection, an analysis that correlates the trends of voltage and current is needed [22], but it is beyond the scope of this article.

V. EXPERIMENTAL RESULTS

In this section, the previously presented measurement methods are applied for on-board monitoring of PQ in a real 3 kV dc RTS. These activities were part of an extensive measurement campaign that has been conducted within the 16ENG04 MyRailS Project [19]. The measurement campaign has been carried out on-board the E464, a dc 3.5 MW locomotive widely used for the commuter transport, during its normal commercial service (see Fig. 3). The campaign, conducted in collaboration with Trenitalia, the biggest Italian railway company, lasted about three months, during which 92 journeys have been monitored and about two terabytes of data have been recorded.

The adopted data acquisition system was based on a National Instruments (NI) Compact Reconfigurable Input Output (cRIO) 9034 equipped with two NI 9223 (four synchronous channels, ± 10 V, 16 bit, 1 MHz maximum sampling rate) and a GPS module NI 9469. The main electrical quantities monitored for PQ assessment are the voltage and current at the pantograph measured before CB (see Fig. 4). For voltage measurement, the resistive-capacitive voltage divider Ultravolt 40TF-CDCD (40 kV/40 V, 0 Hz-1 MHz, 0.25%) has been used. For the measurement of the total current absorbed by the locomotive, the Hall effect transducer LEM HOP 2000 (2 kA/4 V, 0 Hz-10 kHz, $\pm 2\%$, ± 15 V supply) has been used.

Several tests have been performed to characterize the voltage transducer involved in the measurement setup. A complete dc calibration has been performed by using the Italian National

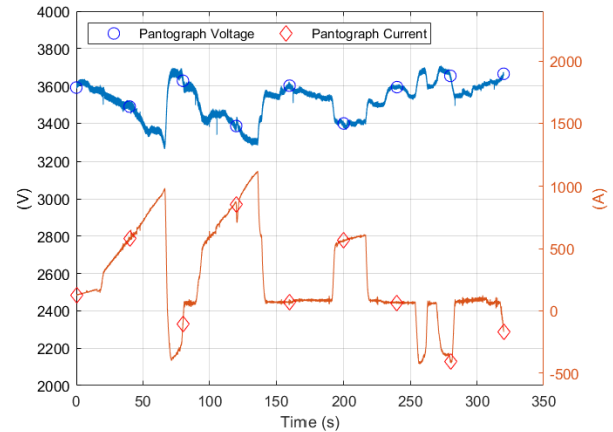

Fig. 4. Voltage and current during Voghera to Alessandria 5-min route.

Reference System for the calibration of dc transducers which provides an uncertainty of $100 \mu\text{V/V}$. The calibration has been performed by applying five values of primary voltage from 1 to 5 kV. The scale factor provided by the calibration is 1016.48 V/V . This value has been used in the postprocessing algorithm to correct the measurement data. The linearity estimation, performed in the range 1–5 kV, provides a relative deviation of 0.1%. Moreover, a characterization campaign has been performed in order to quantify the effect of a sinusoidal ripple on the dc voltage measurement and to estimate the ratio and phase error associated with the ac component transduction when a dc offset is applied. The test foresees the generation of a steady-state primary signal composed of a large dc component and a sinusoidal component of 5% of the dc one. The test has been repeated by changing the dc component from 2 to 4 kV with a step of 500 V. For each dc voltage, a frequency sweep has been performed from 50 Hz to 10 kHz. The results show a maximum oscillation of the dc ratio error within 0.1% in the considered bandwidth. The oscillation falls down to 0.05% in the range 2–10 kHz. The ac ratio error shows a maximum variation of 1% over the considered bandwidth for all the dc voltage levels, the phase error shows a variation from 5 to 12 mrad in the considered bandwidth. Such figures do not change considerably from 2 to 3 kV of the dc voltage level. The phase error varies from 4 mrad at 50 Hz to 7 mrad at 10 kHz for higher dc voltage level. The accuracy associated with the ratio and phase error is $500 \mu\text{V/V}$ and $500 \mu\text{rad}$, respectively. The current transducer has been calibrated by applying a primary signal composed of a dc and a superimposed ac ripple at several frequencies. The ratio error associated with the dc component is 1.6%. The ratio error associated with the ac component varies by 0.6% from 10 to 300 Hz.

Offering an initial idea about the real analyzed waveforms, Fig. 4 shows the voltage at the pantograph and the corresponding absorbed current, measured on-board the train during 5 min of Voghera to Alessandria route (January 25, 2019, 17:37). As it can be seen from the figure, the level of voltage varies from a maximum of about 3708 V to a minimum of 3265 V and it is strongly related to the absorbed current that goes from a minimum of -430 A to a maximum of 1123 A. Negative currents are associated with regenerative braking.

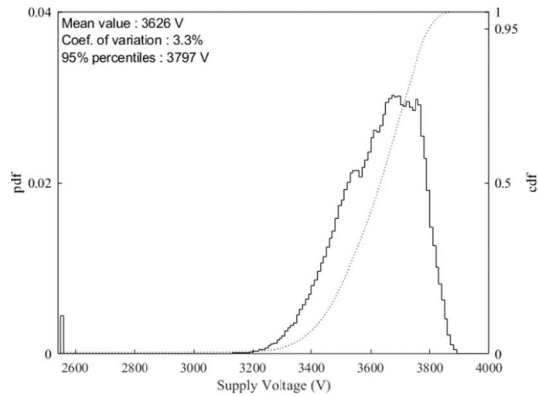

Fig. 5. Statistical analysis of supply voltage over all routes.

The mean voltage over the whole 320 s intervals is 3520 V, which is slightly lower than the maximum permanent voltage for this RTS (see Table I); at each consistent increment of the absorbed current, the voltage drops remarkably. As soon as the brakes were activated to reduce the train speed (time 66–72 s), the voltage increases, suddenly passing from 3265 to 3690 V. It is worthwhile to note that those harsh reported conditions have to be considered normal operating conditions for the railway systems. A total of over 122 h with the moving train were monitored and analyzed.

A. Magnitude of the Supply Voltage

The first task of the PQ monitoring was the assessment of the supply voltage magnitude during different journeys or operation times. In addition to the statistical analysis (see Section IV-A), it is possible to extract the “fingerprint” of each route over time, to analyze deterioration trends.

Fig. 5 shows the statistical analysis of the supply voltages during all the 122 monitored hours.

It is evident that all the most expected values are quite above the nominal value of 3 kV and the average value is even greater than $U_{\max 1}$. The standard deviation is a few percentages of the mean values (about 120 V). The 95% percentile is close to 3.8 kV. The first class of histogram reports the occurrence of all the values less than or equal to 2500 V.

This is a comprehensive behavior that can be used for the maintenance of the train, but it is interesting to show also the statistics of a single route to highlight specific issues. Figs. 6 and 7 show the results obtained for the route, with the greatest and the lowest standard deviation, respectively. The supply system of route 83 (see Fig. 6) seems to be somewhat undersized for rail traffic in the analyzed period and this reflects on a lower average value and on a large variation of the supply voltage. Instead, the impact of absorption is very limited in route 92 (see Fig. 7).

This is also the route with the highest mean value, which is higher than $U_{\max 1}$. If this situation persists over time, it would probably be necessary to change the configuration of the system to reduce the voltage level that is maintained at an unnecessarily high level. The route with the lowest mean value is reported in Fig. 8. This is a route with a high difference in altitude between the two stations (about 1000 m) so large current absorptions characterize this journey and

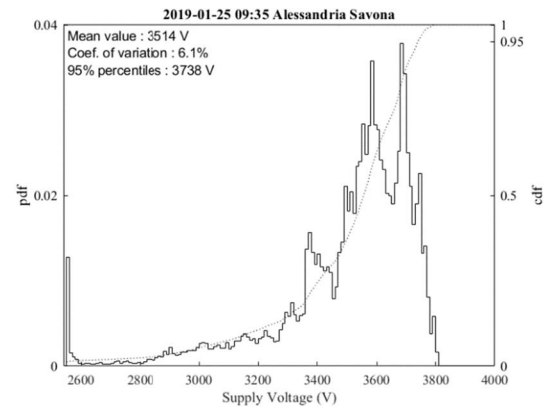

Fig. 6. Statistical analysis of supply voltage of route n. 83.

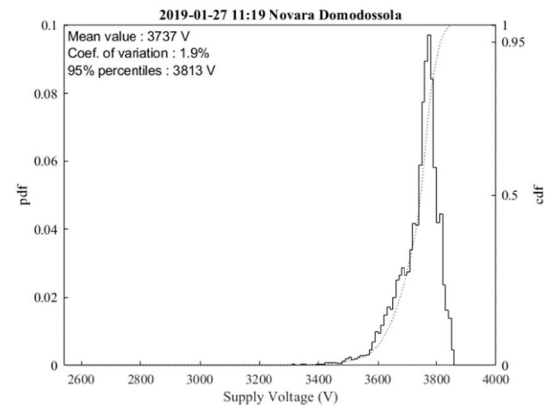

Fig. 7. Statistical analysis of supply voltage of route n. 92.

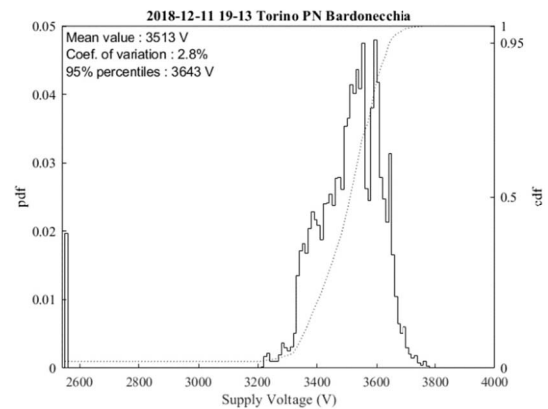

Fig. 8. Statistical analysis of supply voltage of route n. 7.

this impacts the average voltage. During route 6 (Fig. 9), the greatest number of occurrences of voltage level below 2.5 kV was found. According to standard [10], the above-mentioned voltage levels are permitted. Nevertheless, the availability of data recorded in different journeys on the same route allows performing a statistical analysis. The analysis, even though performed on limited samples, highlighted that the low voltage events are present in only one journey. The reasons for this behavior could be a high current absorption from other trains or the out of service of a substation or both. This case demonstrates the importance of a continuous widespread PQ-monitoring system that could help the infrastructure manager in detecting the possible weakness of the supply system.

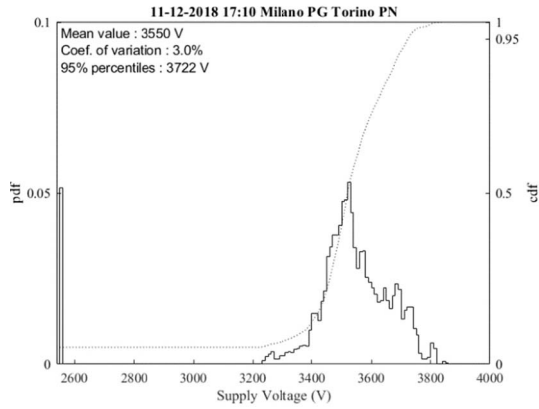

Fig. 9. Statistical analysis of supply voltage of route n. 6.

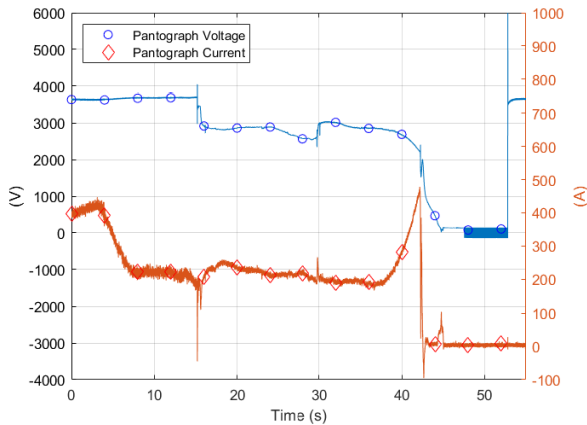

Fig. 10. Dip during Alessandria Savona January 25, 2019, 09:35.

TABLE II
INTERRUPTION EVENT CLASSIFICATION

Duration, T_d [s]	<10	10 – 60	60 – 180	>180
Number of occurrences	4	5	0	1

B. Dips and Interruptions

As previously highlighted in Section IV-C, in the RTS many events (not only PQ events) generate interruptions due to the behavior of the CB. For this reason, the measurement point was chosen before CB (see Fig. 3) to analyze only the event related to RTS.

Nevertheless, no dip was found during the monitoring and all the voltage reductions that exceeded the detection threshold $U_{\min 1}$ caused interruptions.

Ten interruption events were detected in the monitored period classified with the duration, T_d , as reported in Table II. In the following, two of them will be reported and their main features discussed. In Fig. 10, it is apparent the voltage reduction that is not related to current absorption: the voltage drops under $U_{\min 2}$ reaching the values of about 900 V. This event happens during a train stop because before the event the absorbed current is only that required by auxiliary systems (around 70 A). Note that the sudden voltage variations (at times 1 and 4 s) induce a harsh oscillation on the current, probably due to a resonance induced by the train's

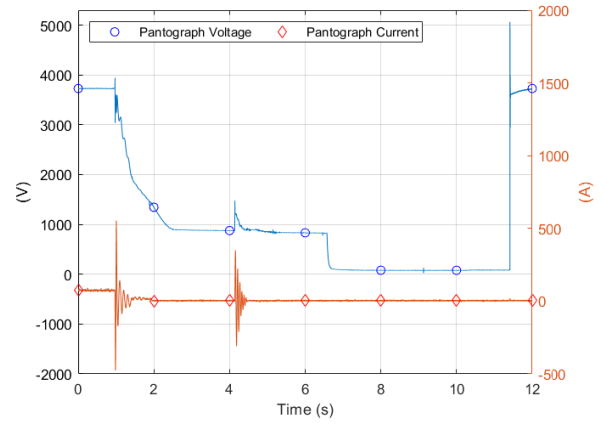

Fig. 11. Dip during Acqui Terme-Alessandria route January 25, 2019, 08:39.

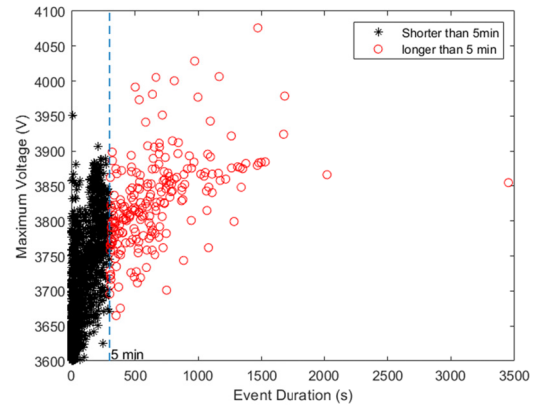

Fig. 12. Duration and amplitude of the detected swell events.

second-order input low pass filter. The second event is more interesting because there is no absorbed current before and after the voltage pulse. For this reason, the current oscillations can be considered not influenced by the load and caused only by the rapid voltage variation. Such a transient oscillation of the current from -304 to $+345$ A is to be considered the normal behavior of the system. After about 5 s, complete disconnection of the voltage applies, probably due to the protection breaker in the substation.

In Fig. 11, at time 15 s, the voltage drops from 3700 to 2900 V (time 15 to 20 s), showing a weakness or overload of the supply line. Anyway, the level was not under $U_{\min 1}$, but, when the train accelerates absorbing about 480 A, the voltage suddenly drops again, causing a further reduction and then an interruption.

This level of current was the same already reached before the event (time 0–5 s), without significant voltage drops, confirming that the required electric power is no more available on the supply line.

C. Voltage Swells

Fig. 12 reports the classification of the maximum voltage versus the duration of all the recorded swell events. The total number of events was 1989, but only 225 last more than 5 min and the maximum voltage reached is greater than $U_{\max 2}$ in

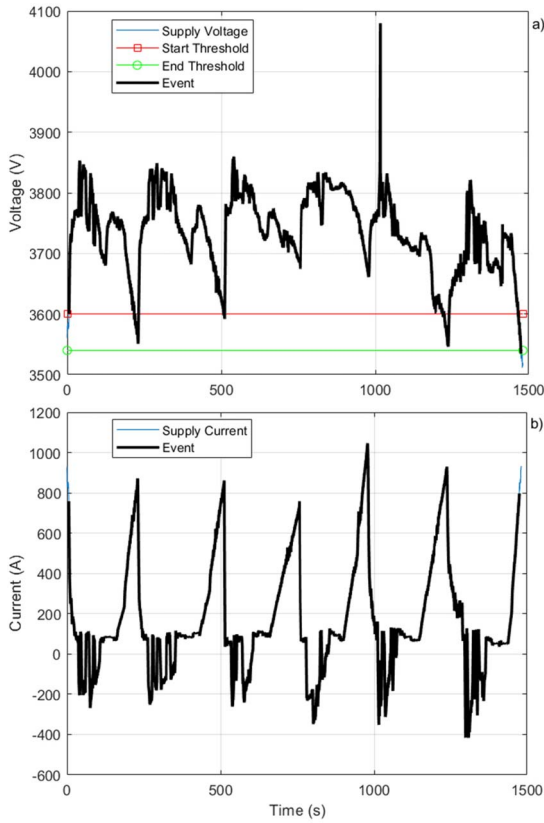

Fig. 13. (a) Voltage and (b) current during swell event 503.

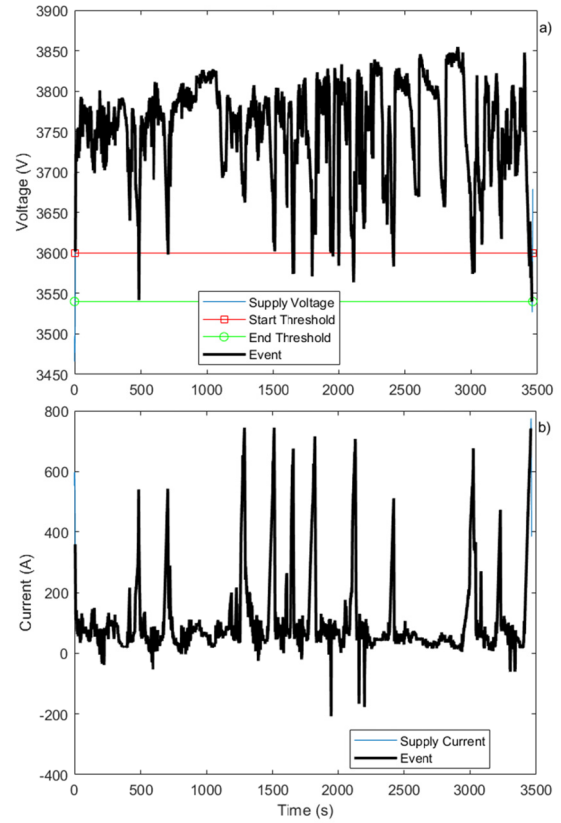

Fig. 14. (a) Voltage and (b) Current during swell event 1950.

only 23 events. Almost all the events refer to stops at stations or braking events. For swell understanding, it is useful to see the corresponding current shape to distinguish between different situations: the stop at station is characterized by a nearly constant low current absorption for a certain long time, while the braking is characterized by negative current.

Fig. 13 reports a swell event related to some braking: during the regenerative braking, the voltage increases overcoming 3.8 kV, but it significantly reduces during current absorption till reaching values lower than 3.6 kV. A value remarkably high (4080 V) was reached during a step reduction of current during a braking. The detection hysteresis adopted (60 V) enlarges event duration so that multiple swells are accounted as a single event, leading the event duration to about 25 min.

Fig. 14 reports a swell event due to a supply line overvoltage and not due to braking or presence of substation. The voltage for a quite long time interval (about an hour) stays above U_{max1} even during the maximum of current absorption. This is the same route as shown in Fig. 7, already identified as the route with the highest average voltage.

D. Distortion of Voltage and Current

Distortion was evaluated by measuring the single spectral components and the TSD as described in Section IV-D. The TSD_U has been calculated as in (1), with a normalization to a nominal value $U_{ref} = 3000$ V.

Fig. 15 reports the statistical analysis of the TSD_U over the entire measurement campaign. It is apparent that the

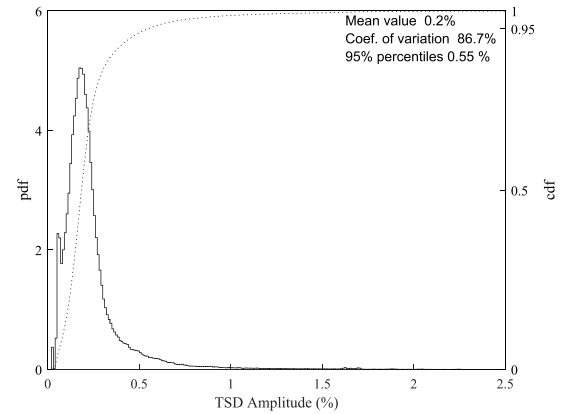

Fig. 15. TSD_U statistical distribution over the whole measurement campaign.

level of distortion is quite low (below 0.55%) for most of the time. Only in infrequent situations, distortion reaches remarkable values. To emphasize this aspect, Fig. 16 shows the worst measured statistic where the TSD_U level reaches some percentage.

This behavior was probably due to a temporary problem of the line filter after the rectification stage in substation, so that an unusual 300 Hz component was injected; see Fig. 17, where the time evolution of this component was reported.

As for current, Fig. 18 shows the statistical analysis of TSD_I over the entire measurement campaign with a normalization to a nominal value $I_{ref} = 1000$ A. As previously stated,

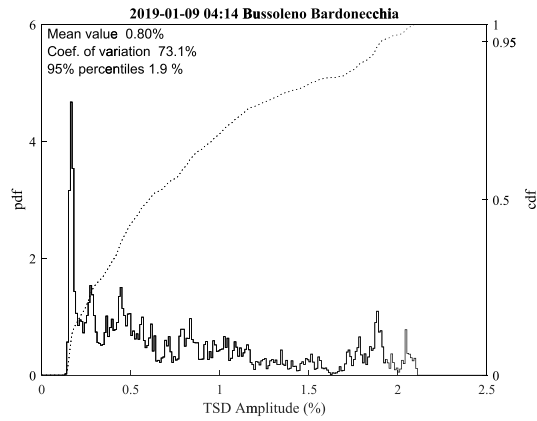

Fig. 16. TSDU statistical distribution for the route n. 39.

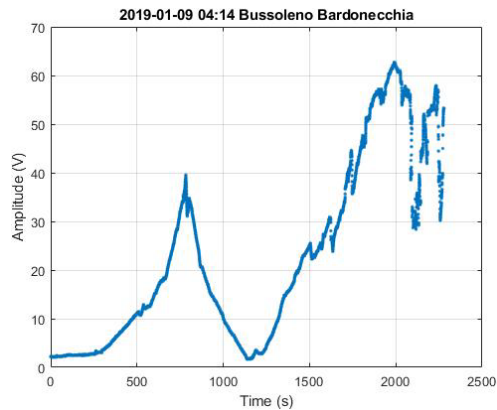
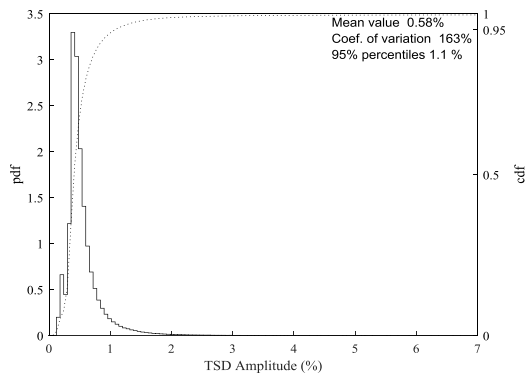

Fig. 17. 300 Hz spectral component during the route n. 39.

Fig. 18. TSD_I statistical distribution over the whole measurement campaign.

the spectral distortion in the current is an issue particularly felt in the railway sector, in fact, the spectral components in the current must be limited under the harmonic envelope defined in [12] and [13] in order not to interfere with signaling systems.

As previously stated, the spectral distortion in the current is an issue particularly felt in the railway sector, in fact, the spectral components in the current must be limited under the harmonic envelope defined in [12] and [13] in order not to interfere with signaling systems.

Fig. 19 reports the worst measured statistic for TSD_I, recorded during a journey “Alessandria—Acqui Terme”. This was the first journey of a snowy day. The ice on the overhead

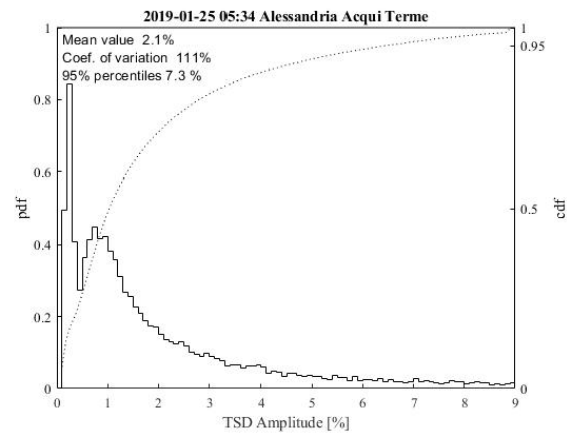

Fig. 19. TSDI statistical distribution for the route n. 81.

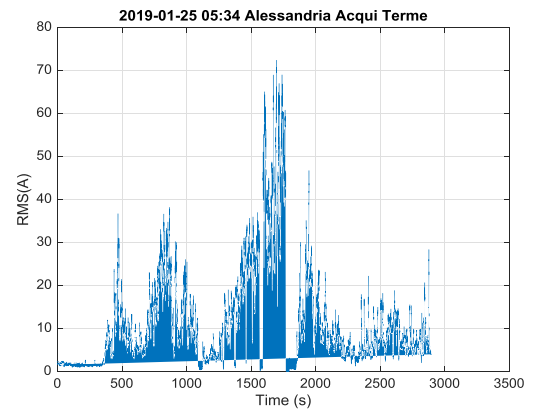

Fig. 20. 15 Hz spectral component during route n. 81.

line, formed during the night, made the contact quality bad, with continuous detachments of the pantograph that provoke arcing effects and even arc-quenching events. These transient events excite the natural oscillation frequency of the locomotive input filter (15 Hz), affecting the current at the pantograph. This effect is clearly shown in Fig. 20, which provides the behavior of the 15 Hz spectral component along the route. Compared with the limit of 10 A, defined by [13] for such frequency, this current component is far beyond the limit for almost all the journey.

E. Transitory Voltages

Fig. 21 reports one of the numerous transient events that were found during the measurement campaign. In particular, it refers to the voltage and current behavior in correspondence of an arc voltage event [22], [23] during a braking stage. At about time 120 ms, the sudden decrease of both voltage and current indicates the arc event, which ends at time 150 ms. The voltage down-step edge stimulates the current oscillation at 15 Hz. When the arc is switched-off, the voltage tends to reach its previous value, and at the same time a new current oscillation is stimulated.

This last voltage oscillation is emphasized by a sudden deviation of the braking energy from the braking rheostat to the line and vice versa during this event. A considerable voltage peak of 5 kV is reached.

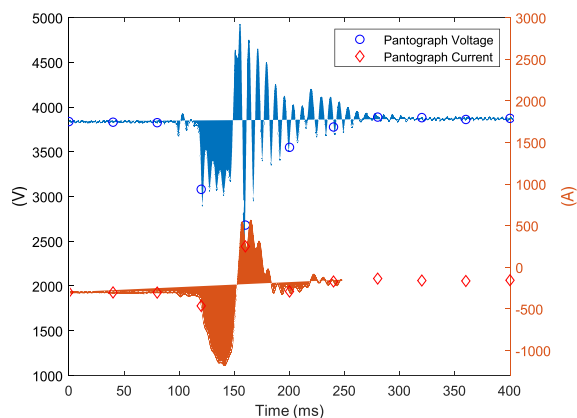

Fig. 21. Voltage arc transient.

VI. CONCLUSION

This article discussed some aspects of the assessment of the PQ, through standardized monitoring techniques, in the railway traction power supply systems. Some limitations to the PQ monitoring performed on-board the train have been reported, warning about possible negative effects on the reliability of the measured results. Two extensions of definitions of basic measurement time intervals adopted in ac 50/60 Hz were proposed to become applicable also in ac 16.7 Hz and the dc system. The measurement procedures of some of the main PQ indexes (interruption, voltage dip/swell and harmonics) were analyzed and extended with minimal changes to become compatible with all railway systems. Proposed techniques were applied to a large measurement campaign. The obtained results were discussed, showing how the PQ indexes can be useful for predictive maintenance or to identify specific problems of the supply system and the train. For instance, the average value of the line voltage is always higher than the nominal voltage of 3 kV. This information could be relevant for the locomotive control system designers and for RTS managers. In fact, the voltage level plays an important role both in defining the control strategy that manages the energy dissipation and recovery during the braking and in defining the maintenance schedule.

REFERENCES

- [1] M. Brenna, F. Foiadelli, and D. Zaninelli, *Electrical Railway Transportation Systems*, Hoboken, NJ, USA: Wiley, 2018.
- [2] Y. Oura, Y. Mochinaga, and H. Nagasawa, "Railway electric power feeding systems," *Jpn. Railway Transp. Rev.*, no. 16, pp. 48–58, Jun. 1998.
- [3] A. Steimel, "Power-electronic grid supply of AC railway systems," in *Proc. 13th Int. Conf. Optim. Electr. Electron. Equip. (OPTIM)*, May 2012, pp. 16–25.
- [4] A. Mariscotti, "Methods for ripple index evaluation in DC low voltage distribution networks," in *Proc. IEEE Instrum. Meas. Technol. Conf. (IMTC)*, Warsaw, Poland, May 2007, pp. 1–4.
- [5] Z. Sun, X. Jiang, D. Zhu, and G. Zhang, "A novel active power quality compensator topology for electrified railway," *IEEE Trans. Power Electron.*, vol. 19, no. 4, pp. 1036–1042, Jul. 2004.
- [6] S. M. M. Gazafurdi, A. T. Langerudy, E. F. Fuchs, and K. Al-Haddad, "Power quality issues in railway electrification: A comprehensive perspective," *IEEE Trans. Ind. Electron.*, vol. 62, no. 5, pp. 3081–3090, May 2015.
- [7] D. Giordano *et al.*, "Accurate measurements of energy, efficiency and power quality in the electric railway system," in *Proc. Conf. Precis. Electromagn. Meas. (CPEM)*, Paris, France, Jul. 2018, pp. 8–13.

- [8] A. Mariscotti, "Direct measurement of power quality over railway networks with results of a 16.7-Hz network," *IEEE Trans. Instrum. Meas.*, vol. 60, no. 5, pp. 1604–1612, May 2011.
- [9] A. Mariscotti, "Measuring and analyzing power quality in electric traction systems," *Int. J. Meas. Technol. Instrum. Eng.*, vol. 2, no. 4, pp. 21–42, Oct. 2012.
- [10] *Railway Applications—Supply Voltages of Traction Systems*, Standards CEI EN 50163:2004+A1, 2007.
- [11] *Railway Applications—Rolling Stock—Testing of Rolling Stock on Completion of construction and Before Entry into Service*, Standards CEI EN 50215, 2011.
- [12] *Railway Applications—Power Supply and Rolling Stock—Technical Criteria for the Coordination Between Power Supply (Substation) and Rolling Stock*, Standard IEC 62313, 2019.
- [13] *Specifica Tecnica FS 370582 (Maschera FS)*. Accessed: Jan. 21, 2020. [Online]. Available: <http://www.ansf.it/documents/19/3733556/370582-1.1%20%28Maschera%20FS96%29.pdf>
- [14] *Testing and Measurement Techniques—Power Quality Measurement Methods*, Standard IEC 61000-4-30, 2015.
- [15] *Testing And Measurement Techniques—General Guide On Harmonics And Interharmonics Measurements And Instrumentation, For Power Supply Systems And Equip Mnt Connected Thereto*. Standard IEC 61000-4-7, 2008.
- [16] M. C. Magro, A. Mariscotti, and P. Pinceti, "Definition of power quality indices for DC low voltage distribution networks," in *Proc. IEEE Instrum. Meas. Technol. Conf. Process.*, Sorrento, Italy, Apr. 2006, pp. 24–27.
- [17] A. D. Femine, D. Gallo, C. Landi, and M. Luiso, "Discussion on DC and AC power quality assessment in railway traction supply systems," in *Proc. IEEE Int. Instrum. Meas. Technol. Conf. (I2MTC)*, Auckland, New Zealand, May 2019, pp. 1–6.
- [18] J. Barros, M. De Apraiz, and R. I. Diego, "Definition and measurement of power quality indices in low voltage DC networks," in *Proc. IEEE 9th Int. Workshop Appl. Meas. Power Syst. (AMPS)*, Sep. 2018.
- [19] G. Crotti *et al.*, "Pantograph-to-OHL arc: Conducted effects in DC railway supply system," *IEEE Trans. Instrum. Meas.*, vol. 68, no. 10, pp. 3861–3870, Oct. 2019.
- [20] D. Gallo, C. Landi, and M. Luiso, "Severity assessment issues for short voltage dips," *Measurement*, vol. 43, no. 8, pp. 1040–1048, Oct. 2010.
- [21] D. Gallo, C. Landi, and M. Luiso, "Accuracy analysis of algorithms adopted in voltage dip measurements," *IEEE Trans. Instrum. Meas.*, vol. 59, no. 10, pp. 2652–2659, Oct. 2010.
- [22] G. Crotti *et al.*, "Pantograph-to-OHL arc: Conducted effects in DC railway supply system," *IEEE Trans. Instrum. Meas.*, vol. 68, no. 10, pp. 3861–3870, Oct. 2019.
- [23] Giordanoii, "Pantograph-catenary arc detection technique based on conducted effects measurement on railway supply system," in *Proc. 2th World Congr. Railway Res. Enhance Customer Experience*, Tokyo, Japan, Oct./Nov. 2018, pp. 1–6.

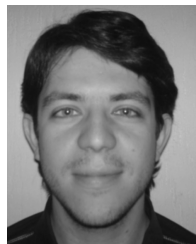

Antonio Delle Femine (Member, IEEE) was born in Caserta, Italy, on March 7, 1980. He received the M.Sc. degree (*summa cum laude*) in electronic engineering and the Ph.D. degree in electrical energy conversion from the University of Campania "Luigi Vanvitelli" (formerly Second University of Naples), Aversa (CE), Italy, in 2005 and 2008, respectively.

From 2008 to 2017, he worked for many national and international companies as a Freelancer. He worked as a Software Engineer, Senior Embedded Firmware Engineer, Hardware Engineer, and Project Manager. He was involved in the design of many products for both industrial and consumer electronics: he worked on fleet-monitoring systems, thermal printers, electronic scales and cash registers, distributed monitoring systems for photovoltaic plants, Hi-Fi radios and home appliances, automatic end-of-line testing systems, augmented reality devices, radioactivity measurement instrumentation (in collaboration with national institute of nuclear physics, INFN, Torino, Italy). Since 2018, he has been a Researcher with the University of Campania "Luigi Vanvitelli". His main scientific interests are the power measurement theory, the design, implementation, and characterization of digital-measurement instrumentation and automatic measurement systems, and the radioactivity measurements.

Dr. Femine is a member of the IEEE Instrumentation and Measurement Society.



Daniele Gallo (Member, IEEE) was born on August 4, 1974. He received the Laurea degree in electronic engineering and the Ph.D. degree in electrical energy conversion from the University of Campania “Luigi Vanvitelli” (formerly Second University of Naples), Aversa (CE), Italy, in 1999 and 2003, respectively.

He is currently an Associate Professor with the University of Campania “Luigi Vanvitelli”. He has authored or coauthored more than 130 articles published in books, international scientific journals, and conference proceedings. His main scientific interests are design, implementation, and characterization of measurement systems for electrical power system, power quality issues, power and energy measurement in nonsinusoidal conditions, design and implementation of smart meter for smart grid application, and electrical transducer characterization.



Domenico Giordano received the Ph.D. degree in electrical engineering with the Politecnico di Torino, Torino, Italy, in May 2007.

Since December 1, 2010, he has been a Researcher with permanent position in the Quality of Life Division, Istituto Nazionale di Ricerca Metrologica (INRIM), Torino. He is currently coordinating the European EMPIR project 16ENG04 MyRailS. His research activities are focused on the development and characterization of systems and voltage/current transducers for calibration and power quality measurements on medium voltage grids and on railway supply systems, on the calibration of energy meters for onboard train installation, and on the study of ferroresonance phenomena. Moreover, he is involved in the development of generation and measurement systems of electromagnetic fields for calibration and dosimetric purposes.



Carmine Landi (Senior Member, IEEE) was born in Salerno, Italy, in 1955. He received the Laurea degree in electrical engineering from the University of Naples, Naples, Italy, in 1981.

He was an Assistant Professor of electrical measurement at the University of Naples “Federico II” from 1982 to 1992. He was an Associate Professor of electrical and electronic measurements at the University of L’Aquila, L’Aquila, Italy, from 1992 to 1999. He has been a Full Professor at the University of Campania “Luigi Vanvitelli” (formerly Second University of Naples), Aversa (CE), Italy, since 1999. He has authored almost 200 international articles in the field of real-time measurement apparatus, automated test equipment, high-precision power measurement, and power quality measurement. His main scientific interests are related to the setup of digital measurement instrumentation, the automatic testing of electrical machines such as asynchronous motors and power transformers, measurement techniques for the characterization of digital communication devices, and the use of digital signal processors for real-time measurements.



Mario Luiso (Member, IEEE) was born in Naples, Italy, on July 6, 1981. He received the Laurea degree (*summa cum laude*) in electronic engineering and the Ph.D. degree in electrical energy conversion from the University of Campania “Luigi Vanvitelli” (formerly Second University of Naples), Italy, Aversa (CE), Italy, in 2005 and 2007, respectively.

He is currently an Associate Professor with the Department Engineering, University of Campania “Luigi Vanvitelli”. He has authored or coauthored more than 150 articles published in books, international scientific journals, and conference proceedings. His main scientific interests are related to the development of innovative methods, sensors and instrumentation for power system measurements, in particular power quality, calibration of instrument transformers, phasor measurement units, and smart meters.

Dr. Luiso is a member of the IEEE Instrumentation and Measurement Society.



Davide Signorino (Student Member, IEEE) was born in Naples, Italy, in 1990. He received the Laurea degree in electronic engineering with a specialization in power electronics from the University of Campania Luigi Vanvitelli, Aversa (CE), Italy. He is currently pursuing the Ph.D. degree in “metrology” with Politecnico di Torino, Torino, Italy.

He currently works on the European EMPIR project 16ENG04 MyRailS. His current research topic, in collaboration with the Italian NMI, is metrology applied to the railway systems, in particular for the power quality and energy exchange between supply line and train analyses, calibration of energy meters, and characterization of voltage and current transducers.