



ISTITUTO NAZIONALE DI RICERCA METROLOGICA Repository Istituzionale

Dataset of measured and commented pantograph electric arcs in DC railways

Original

Dataset of measured and commented pantograph electric arcs in DC railways / Signorino, Davide; Giordano, Domenico; Mariscotti, Andrea; Gallo, Daniele; Femine, Antonio Delle; Balic, Fabio; Quintana, Jorge; Donadio, Lorenzo; Biancucci, Alfredo. - In: DATA IN BRIEF. - ISSN 2352-3409. - 31:(2020), p. 105978. [10.1016/j.dib.2020.105978]

Availability:

This version is available at: 11696/66558 since: 2021-02-05T15:50:38Z

Publisher:

Elsevier

Published

DOI:10.1016/j.dib.2020.105978

Terms of use:

This article is made available under terms and conditions as specified in the corresponding bibliographic description in the repository

Publisher copyright

(Article begins on next page)



Data Article

Dataset of measured and commented pantograph electric arcs in DC railways



Davide Signorino^{a,b}, Domenico Giordano^{a,b,*}, Andrea Mariscotti^{c,d},
Daniele Gallo^e, Antonio Delle Femine^e, Fabio Balic^f,
Jorge Quintana^f, Lorenzo Donadio^g, Alfredo Biancucci^g

^a INRIM, Istituto Nazionale di Ricerca Metrologica, Strada delle Cacce 91, 10135 Torino, Italy

^b Politecnico di Torino Corso Duca degli Abruzzi, 24, 10129 Torino, Italy

^c DITEN, University of Genova, Via Opera Pia 11A, I-16145 Genova, Italy

^d ASTM Sagl, Via Comacini 7, 6830 Chiasso, Switzerland

^e Università della Campania "Luigi Vanvitelli", Via Roma 29, 81031 Aversa CE, Italy

^f Metro de Madrid, C/ Néctar 44, 28022 Madrid, Spain

^g Trenitalia Trenitalia S.p.A., Viale Spartaco Lavagnini 58, 50129 Firenze, Italy

ARTICLE INFO

Article history:

Received 13 June 2020

Accepted 30 June 2020

Available online 3 July 2020

Keywords:

Electric arc

Measurement of electrical quantities

Pantograph

Power quality

Railways

Rolling stock

ABSTRACT

DC railways are characterized by particularly intense arcing caused by pantograph detachment, due to the large current intensity and the general implementation of onboard resonant filters, whose transient response is triggered by electric transients including electric arcs. Electric arc depends on the train speed (the relative speed between the sliding contact over the pantograph and the hot spot on the catenary system), the intensity of the collected pantograph current and the line voltage level. Electric arcs are broadband in nature and can trigger the system transient response dominated by the resonant filter, besides interfering with the operation of onboard equipment (such as for energy conversion and metering).

© 2020 Published by Elsevier Inc.

This is an open access article under the CC BY-NC-ND license. (<http://creativecommons.org/licenses/by-nc-nd/4.0/>)

* Corresponding author. at: INRIM, Istituto Nazionale di Ricerca Metrologica, Strada delle Cacce 91, 10135 Torino, Italy.
E-mail address: d.giordano@inrim.it (D. Giordano).

Specifications Table

Subject	Electrical and Electronic Engineering
Specific subject area	Measurement of electrical quantities, Power Quality
Type of data	Table Graph Figure Raw data provided
How data were acquired	Digitized sampled data using a National Instruments data acquisition system located onboard and connected to voltage and current sensors (voltage dividers, open loop Hall effect transducers and Rogowski coils).
Data format	Raw (sampled waveforms in Matlab .mat binary file, saved also in .txt ASCII file format) analysed (post-processed data in figures)
Parameters for data collection	Data acquisition and digitization with 50 kSa/s sample rate, 16 bit resolution, streaming to solid state disk. Rolling stock electric quantities at pantograph, filter and braking rheostat sensed with characterized transducers whose uncertainty is included. Trains in commercial service.
Description of data collection	A train in normal commercial service along a 3 kVdc railway line or 1.5 kVdc metro line was used in Italy and Spain, respectively, with the acquisition system and sensors installed onboard. The acquisition was run for periods of some days after which data were downloaded from the local solid state disk.
Data source location	1) Italy 3 kVdc railway system, lines: Susa - Torino, Bardonecchia - Torino, Ivrea - Torino. 2) Spain, Metro de Madrid 1.5 kVdc system, line no. 10B
Data accessibility	- With the article (for processed data appearing in figures and tables) - In public repository (for raw data): Repository name: Mendeley Data DOI: 10.17632/74nz86wcgy.1 Direct URL to data: https://data.mendeley.com/datasets/74nz86wcgy/1

Value of the Data

- Recordings of pantograph electrical quantities are difficult to obtain from railway operators for safety and organizational issues, as well as a general data protection concern.
- The dataset may be used for Power Quality studies, analysing the electrical phenomena (e.g. transient harmonics) caused by interaction between the traction supply system and rolling stock of dc railways and metros.
- The dataset may be used to assess transient conducted emissions relevant for interference to railway signalling.
- These selected recordings of electric arcs may be useful also to trim algorithms for electric arc identification and counting.

1. Data Description

The raw data consist of pantograph voltage (v_p) and current (i_p), onboard filter output voltage (v_f) and braking rheostat current (i_r) acquired with an autonomous data acquisition system located onboard of a 3 kVdc railway locomotive and a 1.5 kV metro vehicle. The recordings focus on electric arc events occurring at the current collection system recognized within longer recordings lasting for days. The data are organized dividing them between metro (label “MM” = Metro de Madrid) and railway (label “TI” = Trenitalia), and then for the overall operating condition, namely traction (label “t”) and braking (label “b”), for which the behaviour of the arc is opposite, reducing the line voltage with incoming current the former, increasing the line voltage with exiting current. A simplified circuit that indicates where the electrical quantities are located is shown in Fig. 1.

Data for each electric arc event correspond to a .mat file containing the four measured electrical quantities in double precision format. The same four quantities are also saved in four sep-

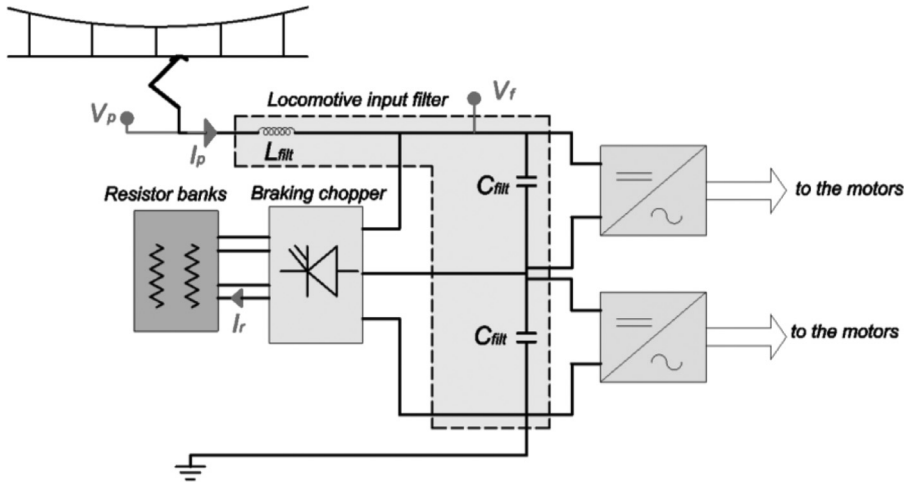

Fig. 1. Schematic of line, current collection, onboard filter and power converters with indication of measured quantities.

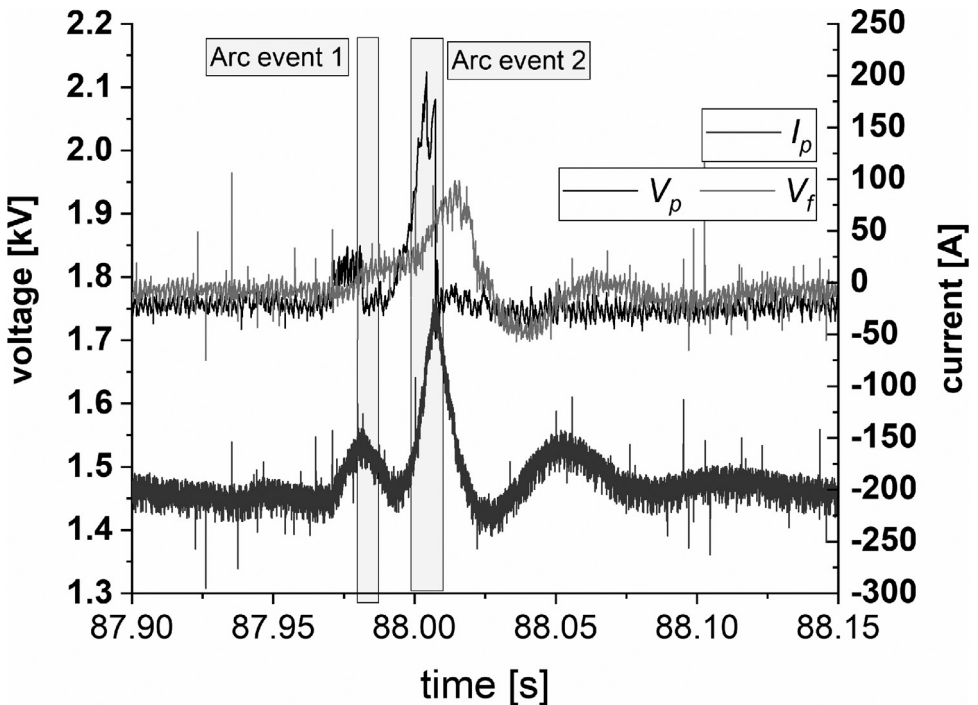

Fig. 2. Waveforms for braking operating condition in 1.5 kV dc metro (file: MM_B_2.tif).

arate ASCII files with .txt extension; they can be distinguished for the appended name of the electrical variable (e.g. _vf.txt). Some pictures in .tif format are also attached for an immediate graphical representation of the waveforms, zooming on the arc even and following transient response.

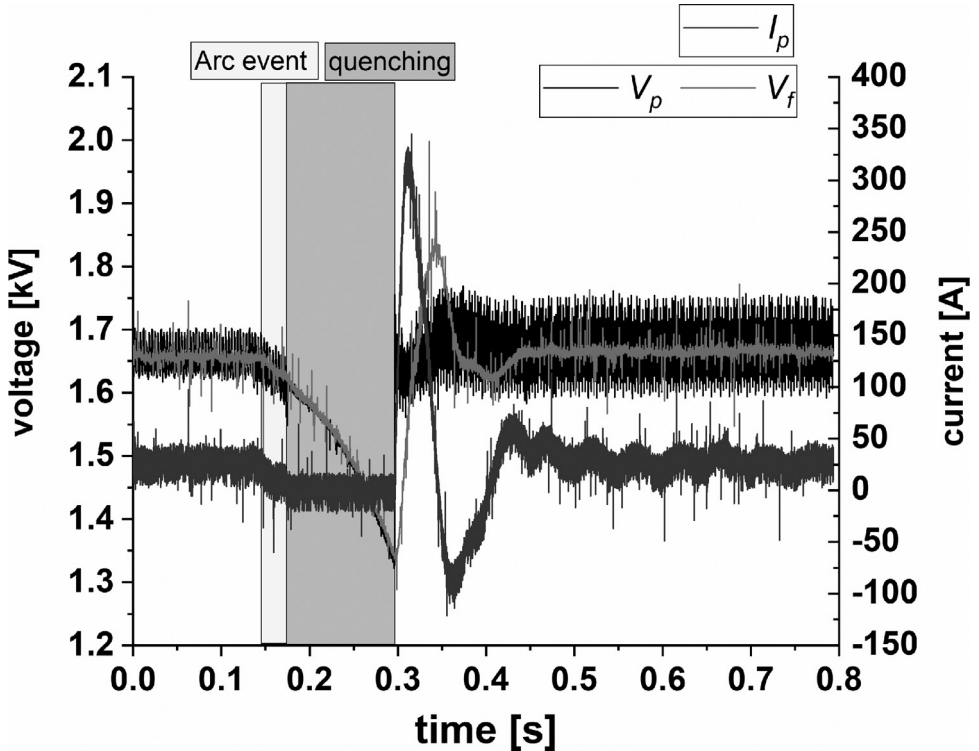

Fig. 3. Waveforms for traction operating condition in 1.5 kVdc metro (file: MM_T_1.tif).

The typical waveforms are shown in Fig. 2 to Fig. 5 selected in braking and traction condition occurring in metro and railway, respectively.

A picture of the data acquisition system is shown in Fig. 6.

2. Experimental design, materials, and methods

The recordings of the pantograph voltage (v_p), and current (i_p), the filter output voltage (v_f) across the filter capacitor and braking rheostat current (i_r) were taken during several days of tests in Italy (using Trenitalia rolling stock) and Spain (along one line in Metro de Madrid) at the end of 2019 within the international research project MyRailS [1]:

- For Italy the rolling stock was a Bombardier E464 locomotive (n. 041) in normal service conditions running on the following railway lines of Piedmont region all fed at 3 kVdc: Susa-Torino, Bardonecchia - Torino, Ivrea - Torino.
- For Spain the rolling stock was a Hitachi Rail electro-train no. S 9000 with three cars in normal service on the line no. 10B of Metro de Madrid.

The v_p and i_p waveforms were processed with an algorithm for electric arc recognition, to extract the portions containing significant electric arc events at the pantograph interface that are then reported in this work. The set of four waveforms (v_p , i_p , v_f and i_r) for each event allows the interpretation of the dynamics of the onboard electric system during such a major transient. The purpose of the MyRailS Project was to characterize the arc events in terms of their own electrical characteristics, as a source exciting the transient response of the input circuit of the rolling stock and in terms of the impact on power consumptions and energy efficiency.

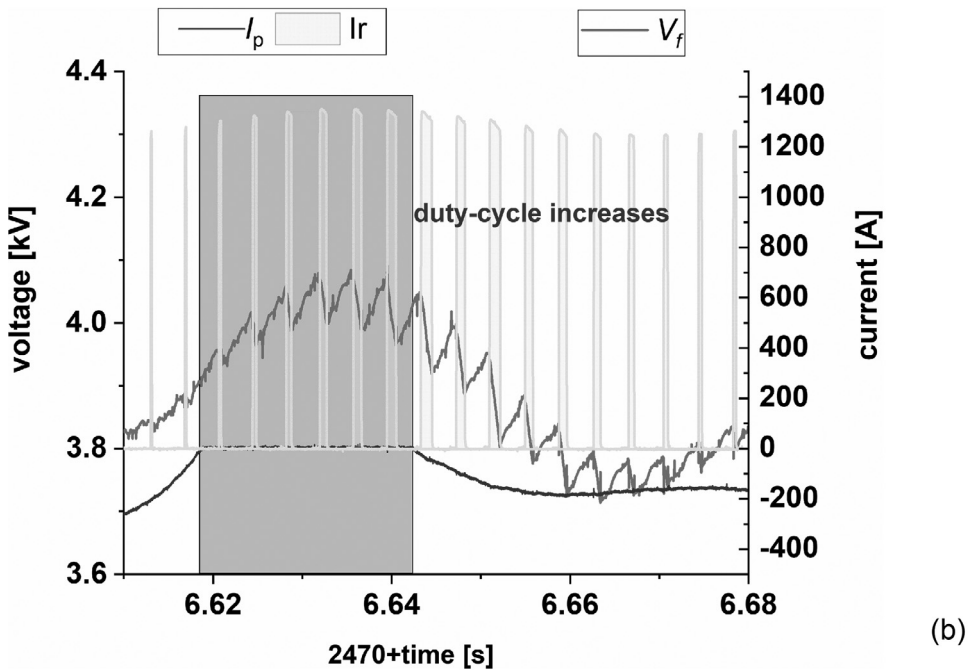
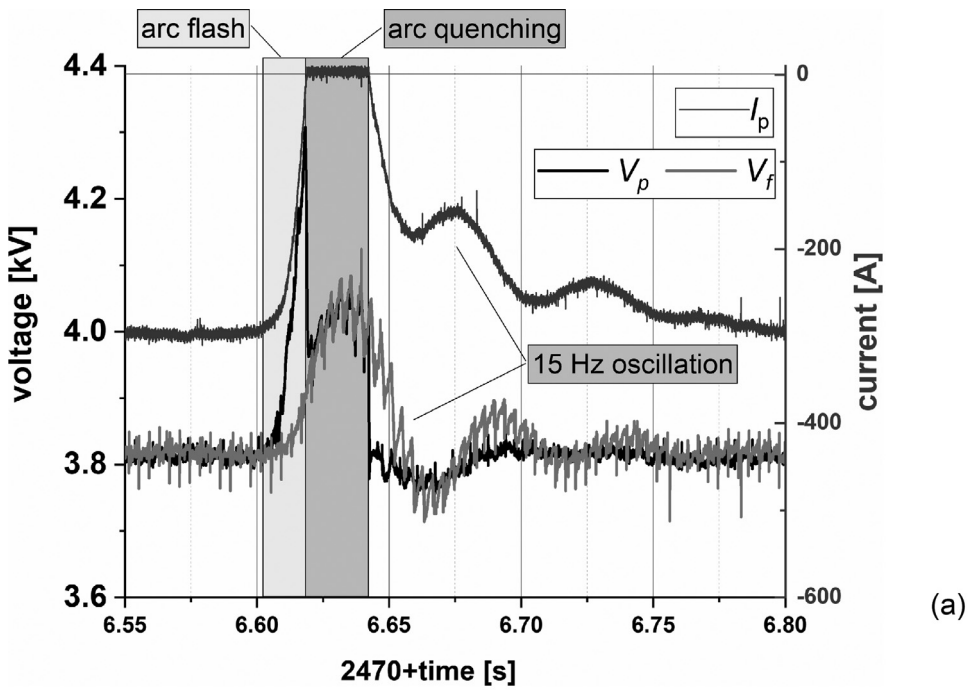

Fig. 4. Waveforms for braking operating condition in 3 kVdc railway (file: TL_B_2.tif): a) behaviour of v_p , v_f and i_p ; b) zoom of the quenching event and the time behaviour of the chopped current i_r .

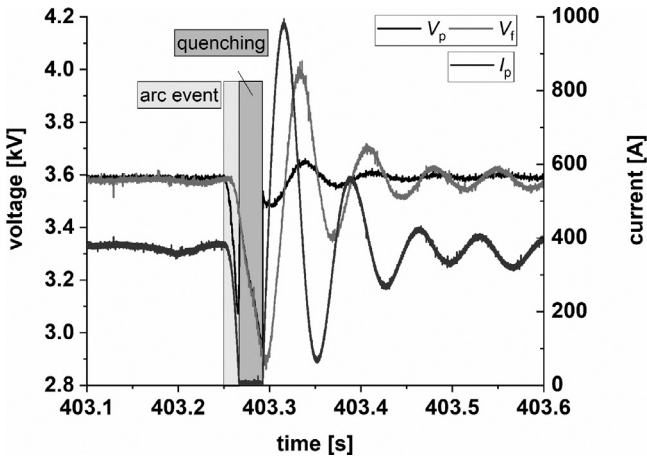

Fig. 5. Waveforms for traction operating condition in 3 kVdc railway (file: TL_T_3.tif).

A high-performance measurement setup was conceived, compatible with the exigency of transportability and ease of installation, as well as the necessary electrical safety and robustness that are required for railway installations and applications.

The data acquisition system (DAS) was built around a National Instrument NI 9239 module and an embedded chassis NI 9034. The NI 9239 features 16 bit data words sampled at 50 kS/s for each channel and can be controlled by a Labview program. The module is interfaced to a GPS synchronization module NI 9467 for general time traceability and for synchronization with the measurements of other DAS in case of network applications.

The electrical quantities are captured using the following transducers:

- For v_p and v_f : Ultravolt TF SERIES voltage transducer with a 1000:1 probe factor and accuracy of 0.25%.
- For i_p : LEM HOP 2000 current transducer with a 2000A/4V probe factor and accuracy $<\pm 2\%$.
- For i_r : Rogowski coil transducer, characterized by INRiM.

All transducers and the DAS were characterized at INRiM before installation and use.

Some factors with metrological relevance were taken into account when devising and installing the measurement system, besides all the exigencies related to electrical safety:

- Electrical noise on the connection cables and equipment, attenuated by using equipotential metallic frame, low-impedance bonding and filters (shown in Fig. 6) and verified by initial manned acquisition for quantification of noise and offsets, at each new installation.
- Location of sensors was optimized, as for Rogowski coils and LEM HOP sensors, centred on the high-voltage cables branching from the pantograph and rheostat to minimize uncertainty.

The dataset (link shown in Appendix A) consists of a set of electric arc events, each one characterized by a set of time domain waveforms of the said four electrical quantities (v_p , i_p , v_f and i_r). These data were extracted from the continuous recordings after having recognized an arc event; the most significant for their characteristics that are commented in the following were selected.

The waveform data can then be processed and analysed in various ways:

- Using Discrete Fourier Transform (DFT) to evaluate the spectral content before, during and after the arc event [2]; due to the transient nature of the electric phenomenon, other spectral analysis methods may be more suitable, such as wavelet packet transform (WPT), joint time-

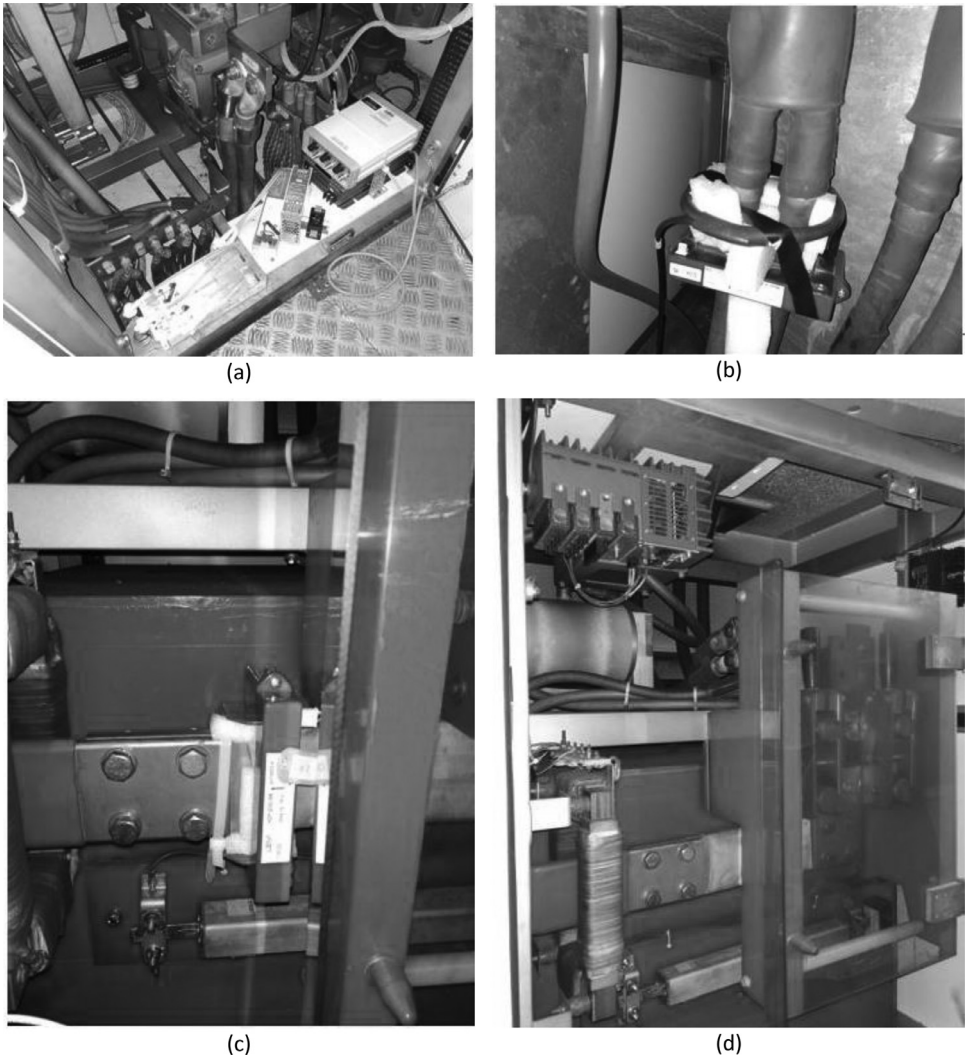

Fig. 6. Installation of the DAS and transducers: a) voltage transducer and supply systems for the active sensors and the DAS; b) Rogowski coil for the i_r measurement; c) HOP sensor for the i_p measurement; d) DAS.

frequency transforms and empirical mode decomposition (EMD), to cite the most widely used approaches.

- Using basic electrical circuit relationships to characterize the behaviour of the circuit and the intensity of the phenomena, such as peak-to-peak variations, rate of rise and rate of fall of transient waveforms, instantaneous impedance, oscillations, etc. [3-6].
- Considering the instantaneous power terms (obtained by the product of the voltage and current quantities) and evaluating the power flow, power dissipation and in general the impact on power consumption and energy efficiency [7].

For reader's ease and to better describe and characterize the data, the following figures show the typical waveforms and the typical electrical phenomena mentioned above and that can be found in the dataset. Each figure is briefly commented.

Fig. 2 highlights two arcs close together during a regenerative braking phase. The first event is very small, the overvoltage of v_p , caused by the arc resistance, is of only some tens of volts. The second event is stronger, the overvoltage of v_p is about 300 V. The otherwise negative current i_p oscillates reaching a very small value close to 0 and then it is re-established to the value before the arc.

Fig. 3 shows an arc event during a traction phase. The absorbed current before the event is very low (about 25 A). Due to such a low current a zero current situation is reached following the filter oscillation and this causes the temporary quenching of the arc for about 120 ms.

Fig. 4 shows an arc event during an electric braking phase. The arc causes an increase of v_p up to 4.3 kV, the current reduces from 300 A to zero amps with a consequent quenching. The increase of the voltage v_f leads to the increase of the braking chopper duty-cycle, that in turn helps limiting the line voltage increase. All the electrical quantities reach again the steady state through a damped oscillation at about 15 Hz, that is the onboard filter oscillation frequency.

Fig. 5 shows an arc event occurring during a traction phase. The locomotive, before the event was absorbing a current of about 400 A. The arc produces a fast voltage and current reduction with a consequent quenching of the arc for about 25 ms. When the contact pantograph-overhead line is again re-established, the i_p reaches again the previous value (400 A) after a strong damped oscillation. In the oscillation, the pantograph current reaches 1 kA.

Appendix A. Supplementary data

Raw data and figures referred in this article can be found online at <https://doi.org/10.17632/74nz86wcgq.1>

Declaration of Competing Interest

The authors declare that they have no competing financial interests or personal relationships which have, or could be perceived to have, influenced the work reported in this article.

Acknowledgments

The results here presented are developed in the framework of the 16ENG04 MyRailS Project. The latter received funding from the EMPIR program co-financed by the Participating States, the European Union's Horizon 2020 research and innovation program and the Swiss State Secretariat for Education, Research and Innovation (SERI).

Supplementary materials

Supplementary material associated with this article can be found, in the online version, at doi:[10.1016/j.dib.2020.105978](https://doi.org/10.1016/j.dib.2020.105978).

References

- [1] EURAMET Joint Research Program. Metrology for smart energy management in electric railway systems, 16ENG04 MyRailS, www.myrails.it.
- [2] A. Mariscotti, Characterization of power quality transient phenomena of DC railway traction supply, *Acta Imeko 1* (1) (2012) 26–35, doi:[10.21014/acta_imeko.v1i1.17](https://doi.org/10.21014/acta_imeko.v1i1.17).
- [3] A.D. Femine, D. Gallo, D. Giordano, C. Landi, M. Luiso, D. Signorino, Power quality assessment in railway traction supply systems, *IEEE Trans. Instrum. Meas.* 69 (5) (2020) 2355–2366, doi:[10.1109/TIM.2020.2967162](https://doi.org/10.1109/TIM.2020.2967162).
- [4] G. Crotti, A. Delle Femine, D. Gallo, D. Giordano, C. Landi, M. Luiso, A. Mariscotti, P. Roccatò, Pantograph-to-OHL arc: conducted effects in DC railway supply system, *IEEE Trans. Instrum. Meas.* 68 (10) (2019) 3861–3870, doi:[10.1109/TIM.2019.2902805](https://doi.org/10.1109/TIM.2019.2902805).
- [5] A. Mariscotti, D. Giordano, Experimental characterization of pantograph arcs and transient conducted phenomena in DC railways, *Acta Imeko 9* (2) (2020) 10–17, doi:[IMEKO-ACTA-09 \(2020\)-02-03](https://doi.org/10.21014/acta_imeko.v9i2.10).

- [6] A. Mariscotti, D. Giordano, A.D. Femine and D. Signorino, Filter transients onboard DC rolling stock and exploitation for the estimate of the line impedance, Proceedings of the Instrumentation and Measurement Technology Conference, May 25-28, 2020, Dubrovnik, Croatia.
- [7] A. Mariscotti, D. Giordano, A.D. Femine and D. Signorino, How pantograph electric arcs affect energy efficiency in DC railway vehicles, Proceedings of Vehicle Power and Propulsion Conference, Oct. 26-29, 2020, Gijon, Spain.