



ISTITUTO NAZIONALE DI RICERCA METROLOGICA Repository Istituzionale

Compensation of Nonlinearity of Voltage and Current Instrument Transformers

This is the author's accepted version of the contribution published as:

Original

Compensation of Nonlinearity of Voltage and Current Instrument Transformers / Cataliotti, Antonio; Cosentino, Valentina; Crotti, Gabriella; Femine, Antonio Delle; Cara, Dario Di; Gallo, Daniele; Giordano, Domenico; Landi, Carmine; Luiso, Mario; Modarres, Mohammad; Tine, Giovanni. - In: IEEE TRANSACTIONS ON INSTRUMENTATION AND MEASUREMENT. - ISSN 0018-9456. - 68:5(2019), pp. 1322-1332. [10.1109/TIM.2018.2880060]

Availability:

This version is available at: 11696/60047 since: 2021-01-29T23:32:49Z

Publisher:

IEEE

Published

DOI:10.1109/TIM.2018.2880060

Terms of use:

This article is made available under terms and conditions as specified in the corresponding bibliographic description in the repository

Publisher copyright

IEEE

© 20XX IEEE. Personal use of this material is permitted. Permission from IEEE must be obtained for all other uses, in any current or future media, including reprinting/republishing this material for advertising or promotional purposes, creating new collective works, for resale or redistribution to servers or lists, or reuse of any copyrighted component of this work in other works

(Article begins on next page)

Compensation of Non-Linearity of Voltage and Current Instrument Transformers

Antonio Cataliotti, *Member, IEEE*, Valentina Cosentino, *Member, IEEE*, Gabriella Crotti, Antonio Delle Femine, *Member, IEEE*, Dario Di Cara, *Member, IEEE*, Daniele Gallo, *Member, IEEE*, Domenico Giordano, Carmine Landi, *Senior Member, IEEE*, Mario Luiso, *Member, IEEE*, Mohammad Modarres, and Giovanni Tinè, *Member, IEEE*

Abstract—This paper aims at characterizing and improving the metrological performances of Current (CT) and Voltage Instrument Transformers (VT) in harmonic measurements in power system. A theoretical analysis is carried out to demonstrate that, due to the iron core non linearity, CT and VT output signal is distorted even when the input signal is a pure sinusoidal. Starting from this analysis, a new method for CT and VT characterization and compensation is proposed. In a first step, they are characterized in sinusoidal conditions and the harmonic phasors of the distorted output are measured; in the second step, these phasors are used to compensate the harmonic phasors measured in normal operating conditions, which are typically distorted. The proposed characterization and compensation techniques are called SINDICOMP (SINusoidal characterization for DIstortion COMPensation). Several experimental tests, using high accuracy calibration setups, have been performed to verify the proposed methods. The experimental results showed that the SINDICOMP technique assures a significant improvement of CT and VT metrological performances in harmonic measurements.

Index Terms—Instrument Transformers, Power System Measurement, Harmonics, Power Quality, Uncertainty

I. INTRODUCTION

HARMONICS measurement has become a very important issue in modern power systems, where distortion levels are steadily growing because of the presence of polluting equipment (such as power electronics of both active and passive users devices). Power quality and distortion levels assessment, disturbances source detection and also metering protection and compensation functions require accurate harmonic measurements [1]-[7].

To this aim, in the measurement chain a key role is played by measurement transducers. Even if they are not fully addressed by the current standards on power quality and harmonic measurements [8]-[9], they are known to give a significant

contribution to measurement uncertainty, even in sinusoidal conditions. Furthermore, their metrological features in the presence of harmonics can significantly reduce, depending on their operating principle [10]-[15]. In fact, while the behavior of electronic instrument transformers (Rogowski coils, Hall effect sensors, etc.) can be considered to have very low non-linearity error in both frequency and amplitude, such assumption is not valid when dealing with inductive voltage and current instrument transformers (CTs and VTs). In the first case, the transducer single tone frequency response can be used to estimate their behavior with distorted voltage/current signals and the impact on measurement uncertainty both at fundamental and harmonic frequencies [16]-[17]. On the contrary, for inductive VTs and CTs, ratio and phase errors limits are defined only at fundamental power system frequency [18]-[19] whereas their metrological characterization in the presence of harmonics is an important aspect, since they are widely employed in power systems.

The inherent nonlinear behavior of CTs and VTs, makes the frequency response not appropriate for their metrological characterization and the assessment of their contribution to measurements uncertainty when dealing with non-sinusoidal signals. VTs and CTs behavior in the presence of harmonics should be studied by directly using distorted waveforms, instead. This entails the need of defining proper test procedures for the assessment of VTs and CTs metrological features and impact on harmonics measurements.

To face this issue, different approaches have been proposed in literature. Regarding the definition of proper test waveforms, the Standard IEC 60044-8 [17] suggests to use “realistic” waveforms which should represent normal non-sinusoidal operating conditions. The suggested test waveforms are composed by a fundamental component (with rated primary amplitude at power system frequency) plus harmonic components with lower amplitudes. An alternative approach is

A. Cataliotti and V. Cosentino are with the Department of Energy, Information Engineering and Mathematical Models, University of Palermo, Viale delle Scienze, Ed. 9, 90128 Palermo, Italy (e-mail: antonio.cataliotti@unipa.it, valentina.cosentino@unipa.it).

G. Crotti, D. Giordano and M. Modarres are with Istituto Nazionale di Ricerca Metrologica (INRIM), Strada delle Cacce 91 - 10135, Torino, Italy (e-mail: g.crotti@inrim.it, d.giordano@inrim.it).

A. Delle Femine, D. Gallo, C. Landi and M. Luiso are with the Department of Engineering, Università degli Studi della Campania “Luigi Vanvitelli”, Via

Roma 29, 81031 Aversa (CE) (e-mail: antonio.dellefemine@unicampania.it, daniele.gallo@unicampania.it, carmine.landì@unicampania.it, mario.luiso@unicampania.it)

D. Di Cara, and G. Tinè are with the Institute of Marine Engineering, National Research Council of Italy, via Ugo La Malfa 153, 90146 Palermo, Italy (e-mail: dario.dicara@cnr.it, giovanni.tine@cnr.it).

based on a quasi-logarithmic multi-sine signal, which can allow the analysis over a wide frequency range [25]. The main problem with this approach is the very long duration of the characterization tests and the difficulty in generation of complex test waveforms, which must fulfill proper accuracy requirements in the frequency band of interest. As regards the set-up, some literature solutions are based on an arbitrary waveform generator connected to an amplifier and a step-up transformer [26]. A reference transducer is then used to accurately measure the harmonic components of the distorted output signal. An alternative method is proposed in [27], [28] for the frequency characterization of medium voltage transformers: a two steps procedure, based on high voltage gas insulated capacitors and a digital bridge, allowing calibrations in distorted conditions up to 15 kHz, is used.

Some techniques to improve performance of VTs and CTs are present in scientific literature. Some of them, [29]-[31], are based on additional analog hardware, whereas some others, [32]-[33], are based on digital signal processing. On the other hand, those methods were not focused on increasing the accuracy performance in harmonic measurements.

In previous works, some of the authors proposed the use of test waveforms composed by the fundamental component plus one harmonic component [34]-[37], with the aim to study the impact of harmonics amplitude and phase on the transducers metrological performances, both at fundamental and harmonic frequencies. The proposed test methodology is different with respect both to literature proposals and to inductive IT standard procedures [18]-[19]. It is also different from the method suggested for electronic ITs [17], where harmonics amplitudes and phases variability is not considered. The proposed testing procedure, instead, allowed demonstrating that CTs and VTs errors in harmonic measurements have a high variability with harmonics amplitudes and phases.

In this paper, this phenomenon will be theoretically analyzed. It will be shown that, due to iron core non linearity, the transformer output signal is distorted even when a sinusoidal signal is applied at its input terminals. Thus, a new simple characterization method will be suggested, which allows characterizing CT and VT behavior in harmonic measurements starting from sinusoidal tests. A compensation method will be then proposed which allows reducing the errors due to the non-linearity. The proposed characterization and compensation techniques are called SINDICOMP (SINusoidal characterization for DIstortion COMPensation). With respect to other methods proposed in literature [29]-[33], SINDICOMP is simpler. In fact, it proposes to use the sinusoidal tests, already prescribed by standards [16]-[24], to characterize the IT behavior even at harmonic frequencies. Thus the method can be easily implemented in those laboratories which are already equipped for IT compliance tests only by implementing the proposed frequency analysis. Another advantage of SINDICOMP is the low computational load of the compensation method. Therefore, it can be easily implemented also on low cost instruments to improve the accuracy in harmonic measurement.

New calibration setups will be used to perform the

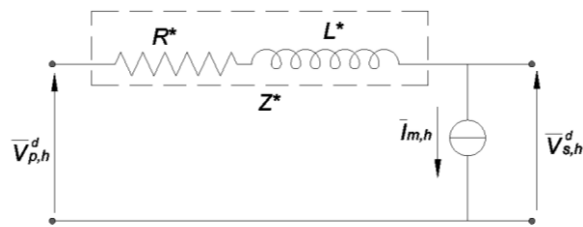

Fig. 1. Equivalent circuit of VT at h -order harmonic frequency.

experimental tests, achieving measurement accuracy higher than that obtained in the previous studies. With the developed test set-up, the compensation method will be verified applying distorted input signals and comparing the ratio and phase errors at each harmonic component before and after the compensation.

The paper is organized as follows. Section II analyzes, from a theoretical point of view, the CT and VT non-linear behavior at harmonic frequency and it also presents the proposed compensation method. Section III shows the experimental setups for CT and VT characterization in distorted conditions. Section IV describes the SINDICOMP technique, while it is experimentally verified on commercial CT and VT in Section V. Finally, Section VI draws the conclusion.

II. THEORETICAL BACKGROUND

A. Non linearity modeling

As demonstrated in [37], CTs and VTs harmonic ratio and phase errors strongly depend on harmonic phase shift with respect to fundamental. In the following, it will be shown how this phenomenon is a direct consequence of the non-linearity introduced by the magnetic characteristic of the silicon-iron core.

For sake of brevity, here a VT is considered: the same theoretical results can be obtained for a CT with minor changes.

When a perfectly sinusoidal voltage is applied to the primary terminals of a VT, the magnetic core hysteresis behavior causes a distortion in the magnetization current. This can be easily observed measuring the magnetization current in an open circuit test and analyzing its harmonic content. To take into account this phenomenon, the VT behavior at h -order harmonic frequency can be described with the simplified model shown in Fig. 1. It is worth to emphasize that, in the model and in the following formulas, primary quantities are referred to the secondary side of the transformer, thus the transformation ratio k_{VT} is not made explicit. A current generator is used to model the harmonic component $\bar{I}_{m,h}$ of the magnetization current. For a rigorous physical approach, this quantity mainly depends on the hysteresis loop characteristics, that is on the peak and on the frequency of the applied voltage, i.e., $\bar{I}_{m,h} = f(V_{peak}, f)$. Assuming that the considered signals are constituted by the combination of a large signal at the fundamental frequency and small signals at higher frequencies and that the transformer core working point is far from the saturation knee, we can state that $\bar{I}_{m,h}$ only depends on the fundamental amplitude and frequency, i.e., $\bar{I}_{m,h} = f(V_{fund}, f)$.

The model also includes the series impedance \dot{Z}^* , which represents the equivalent resistance R^* and leakage inductance L^* of the primary winding:

$$\dot{Z}^* = R^* + j \cdot 2\pi f \cdot h \cdot L^* \quad (1)$$

where h is the harmonic order. Thus, even when a sinusoidal voltage is applied to the primary winding, a distorted secondary voltage is measured at secondary winding, whose harmonic component is:

$$\bar{V}_{s,h}^{sin} = -\dot{Z}^* \cdot \bar{I}_{m,h} \quad (2)$$

where the superscript “sin” indicates a phasor obtained in a sinusoidal test.

Let now consider the case of a distorted voltage applied at primary terminals, which is composed of a fundamental and an h -order harmonic. The phase shift of the harmonic component with respect to fundamental, $\delta_{p,h} = \varphi_{p,h} - h \cdot \varphi_{p,1}$, is varied in the range $[-\pi, \pi]$.

Thus the harmonic phasor of the primary voltage is:

$$\bar{V}_{p,h}^d = |\bar{V}_{p,h}^d| \cdot e^{j\varphi_{p,h}} = |\bar{V}_{p,h}^d| \cdot e^{j(\delta_{p,h} + h \cdot \varphi_{p,1})} \quad (3)$$

where $\varphi_{p,1}$ and $\varphi_{p,h}$ are the phase angles of fundamental and harmonic components, respectively; the superscript letter “d” indicates a phasor obtained in distorted conditions.

For each phase shift, the voltage ratio and phase error associated with the h -th harmonic can be computed as:

$$\varepsilon_h = \frac{|\bar{V}_{s,h}^d| - |\bar{V}_{p,h}^d|}{|\bar{V}_{p,h}^d|} \cdot 100 \quad (4)$$

$$\Delta\varphi_h = \varphi_{s,h} - \varphi_{p,h} \quad (5)$$

where $\varphi_{s,h}$ is the phase angles of h -order harmonic secondary voltage $\bar{V}_{s,h}^d$. To verify that these errors are mainly due to the harmonic phasors generated by core non linearity, a comparison is performed between ratio and phase errors measured in distorted tests (i.e. directly measuring $\bar{V}_{s,h}^d$) and those obtained by calculating $\bar{V}_{s,h}^d$ as:

$$\bar{V}_{s,h}^d = \bar{V}_{p,h}^d - \dot{Z}^* \cdot \bar{I}_{m,h} \quad (6)$$

In order to give a preliminary proof of the validity of the model, some experiments made on a real $20/\sqrt{3}$ kV VT are presented in this section. Exhaustive discussion on experimental results will be shown in the next sections.

The comparison between model and experimental results has been performed focusing on the third harmonic component. The measured series parameters for the primary winding are: $R^* = 8.2$ k Ω and $L^* = 17.5$ H, while the rated transformation ratio is 200. Applying a sinusoidal primary voltage with an amplitude of 120 % of the rated value, the third harmonic component $\bar{I}_{m,h}$ measured amplitude was 95 μ A with a phase shift of about -1.33 rad. Ratio and phase errors at third harmonic component, from the model output and experimental tests, are shown in Fig. 2. It has to be underlined that the magnetization current has a fixed phase shift with respect to the fundamental.

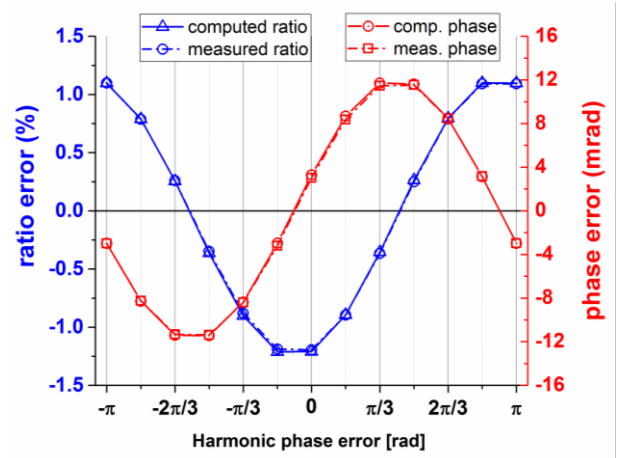

Fig. 2. Comparison between computed and measured ratio and phase errors.

Thus, phasor $\bar{V}_{s,h}^d$ calculated with equation (6) is the composition of a phasor with fixed phase shift, $\dot{Z}^* \cdot \bar{I}_{m,h}$, and a phasor, $\bar{V}_{p,h}^d$, whose phase shift is varied according to (3). This explains the error variability with the phase shift $\delta_{p,h}$. A good overlap between model computation and experimental results is demonstrated by the low root mean square error (RMSE): 124 μ V/V and 143 μ rad for the ratio and phase error respectively. Since, as assumed before, $\bar{I}_{m,h}$ depends only on the fundamental component and \dot{Z}^* is a parameter of the VT, this allows to conclude that the errors due to non-linear behavior can be estimated by considering the VT harmonic response in a sinusoidal test.

B. Compensation Method

Starting from the previously mentioned considerations, a compensation method is here proposed.

The primary voltage can be obtained by combination of the equations (2) and (6):

$$\bar{V}_{p,h}^d = \bar{V}_{s,h}^d + \dot{Z}^* \cdot \bar{I}_{m,h} = \bar{V}_{s,h}^d - \bar{V}_{s,h}^{sin} \quad (7)$$

i.e., the secondary voltage harmonic components measured in sinusoidal conditions, $\bar{V}_{s,h}^{sin}$, can be used to correct the harmonic components measured in distorted conditions, $\bar{V}_{s,h}^d$, thus reducing the ratio and phase errors due to the VT non-linearity. This result is of a particular importance. In fact, in a first step, the VT can be characterized in sinusoidal conditions, following a procedure identical to those proposed by [16]-[24]; the only difference is that, for every sinusoidal input, also the output harmonics phasors must be measured. Then, in a second step, that is when using the VT in actual measurements with distorted waveforms, the harmonic phasors at primary winding can be obtained combining the harmonic phasors measured at secondary winding with the corresponding harmonic phasors measured in the first step.

It is worth to underline that $\bar{V}_{s,h}^{sin}$ can be measured more easily than $\dot{Z}^* \cdot \bar{I}_{m,h}$. $\bar{V}_{s,h}^{sin}$ mainly depends on fundamental amplitude and phase. Thus, in order to correctly apply the compensation method, the phase error at fundamental frequency should be firstly evaluated and compensated, to

properly consider the phase shifts of each harmonic phasor with respect to fundamental. More in detail, the harmonic phase shift at the secondary terminals can be calculated as:

$$\delta_{s,h} = \varphi_{s,h} - h(\varphi_{s,1} - \Delta\varphi_1) \quad (8)$$

where $\varphi_{s,h}$ and $\varphi_{s,1}$ are the phase angles of the harmonic and the fundamental component at the secondary terminals, while $\Delta\varphi_1$ is the phase error at fundamental evaluated with equation (5).

Dual procedures can be applied for CTs compensation. The harmonic phasors of the primary current can be obtained as:

$$\bar{I}_{p,h}^d = \bar{I}_{s,h}^d - \bar{I}_{s,h}^{sin} \quad (9)$$

i.e., the secondary current harmonic components measured in sinusoidal conditions, $\bar{I}_{s,h}^{sin}$, are used to correct the harmonic components measured in distorted conditions, $\bar{I}_{s,h}^d$.

The proposed method is very simple, because only a characterization in sinusoidal conditions is required, which can be easily performed in industrial laboratories.

III. EXPERIMENTAL SETUPS

A. Low voltage Signal Generation and Acquisition

The setups used for CT and VT characterization have the same structure, shown in Fig. 3. The general architecture is composed by: a low voltage signal generator, an amplifier, a reference transducer (REF in Fig. 3) and the instrument transformer (IT) under test.

In particular, signal generation, signal acquisition, synchronization and measurement software are the same. Therefore, in this subsection the common elements are described, while in the next subsections the specific parts are presented.

The signal generation is obtained by means of an Arbitrary Waveform Generator (AWG), the NI PXI 5421, with 16 bit, variable output gain, ± 12 V output range, 200 MHz maximum sampling rate, 256 MB onboard memory. It is inserted in a PXI chassis, and the 10 MHz PXI clock is used as reference clock for its high resolution Phase Locked Loop circuitry. The generation frequency of the AWG is therefore chosen to be an integer multiple of the generated fundamental frequency. Another AWG is used to generate a 12.8 MHz clock, which is used as time base clock for the comparator [38]. This is based on the NI cDAQ chassis with four different acquisition modules: NI 9225 (± 425 V, 24 bit, 50 kHz), NI 9227 (± 14 A, 24 bit, 50 kHz), NI 9239 (± 425 V, 24 bit, 50 kHz), NI 9238 (± 500 mV, 24 bit, 50 kHz). The sampling clock of the comparator is derived from the 12.8 MHz time base clock. In this way, generation and acquisition are precisely synchronized.

The measurement software has been written in LabVIEW, using the event-based state machine approach.

Once the signal is generated, the software waits a variable time interval, depending on the setup configuration, in order to be sure that all the devices are at the right operating temperature. Then, the output waveforms of the reference transducer (REF) and of the instrument transformer under test

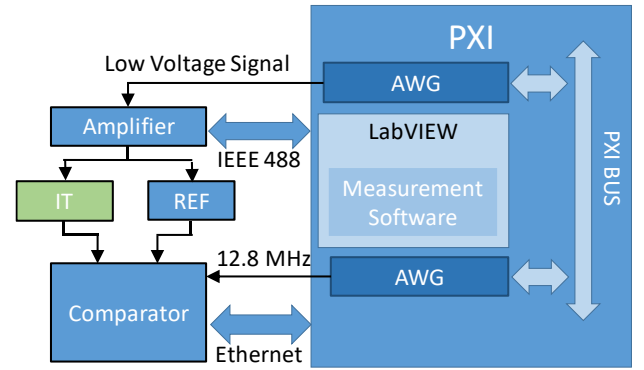

Fig. 3. Generalized block diagram of the calibration setups

(UT) are sampled simultaneously and stored into files. The sampling frequency is chosen accordingly to the maximum frequency content of the performed test; however, its minimum value is 10 kHz. The samples stored into files are then post-processed in MatLab environment. Various types of tests can be chosen: sinusoidal frequency sweep, fundamental tone plus sweeping harmonic tone, fundamental tone plus amplitude and/or phase modulation. Moreover, sweeps on all the parameters of the waveforms can be performed, f.i. fundamental amplitude and/or frequency, harmonic order, amplitude and/or phase, modulation frequency and so on.

B. Current Generation and Reference

The setup for the calibration of CTs has been realized at University of Campania.

Current generation is obtained through the transconductance amplifier Fluke 52120A (up to 120 A, up to 10 kHz). It is driven by the AWG output and it is remotely controlled by the PXI chassis through the IEEE 488 bus. Current reference value is obtained by means of a set of calibrated current shunts, Fluke A40B series, the 1 /0.8 A/V, the 5 /0.8 A/V, the 20 /0.8 A/V and the 100 /0.8 A/V. They are among the most accurate current shunts, with wide input frequency range, actually in commerce, with best accuracy of some parts per million.

All the systematic errors of the system, including frequency responses of the reference shunts and of the digitizers, are accounted. A thoroughly evaluation of the system performance in the presence of harmonics was presented in [38]. The maximum expanded uncertainties (coverage factor equal to 3) of the system on ratio and phase errors, in distorted conditions (as those used in this paper), are 150 μ A/A and 150 μ rad up to 5 kHz.

C. Medium Voltage Generation and Reference

The setup for the calibration of VTs has been realized at INRIM.

The voltage waveform generated by the AWG is amplified by a Trek high-voltage power amplifier (30 kV_{peak}, 20 mA_{peak}) with wide bandwidth (from DC to 2.5 kHz at full voltage and 30 kHz at reduced voltages), high slew rate (<550 V/ μ s) and low noise.

Voltage reference is obtained by means of a 30 kV wideband reference divider designed, built and characterized at INRIM

([28], [39]). As for the setup for CT calibration, also for this setup all the systematic errors of the system, including frequency responses of the reference divider and of the digitizers, are accounted.

The maximum expanded uncertainty (coverage factor equal to 3) associated with the calibration setup, for the considered frequencies, is of the order of $200 \mu\text{V/V}$ and $200 \mu\text{rad}$ for the estimation of the ratio and phase error respectively up to 3 kHz. A single line diagram and a picture of the test setup are provided in Fig. 4a and b, respectively.

IV. SINDICOMP: VT AND CT SINUSOIDAL CHARACTERIZATION FOR DISTORTION COMPENSATION

A. Preliminary considerations

As shown in [34] and [37], CT and VT metrological performances in distorted conditions cannot be assessed by using the frequency response, **that is using single tone signals**. Thus, **tests** with a distorted primary voltage (or current) composed of a fundamental and an h -order harmonic **are** suggested. The tests are performed at different phase shift of the harmonic component with respect to fundamental, $\delta_{p,h}$, in the range $[-\pi, \pi]$. Ratio and phase errors are measured according to (4) and (5), for different harmonic components. The errors measured performing these tests on different CTs and VTs had a strong dependence on phase shift and their maximum values cannot be predicted with a single test in distorted condition with a fixed phase shift.

On the other hand, the theoretical study of Section II demonstrated that, **performing a sinusoidal test and measuring the harmonic components present at the secondary, the harmonic ratio and phase errors variability with phase shift, can be predicted**. Thus a simplified method is here proposed for CT and VT behavior characterization in distorted conditions.

B. Characterization Method

The technique here proposed for the characterization and the compensation of VTs and CTs is executed in two steps.

In the first step, the characterization of the IT is performed with sinusoidal input. This procedure allows to measure the harmonic phasors introduced by the IT on the output signal, that can be used for performance compensation in normal working conditions. Obviously, for best results the characterization should be repeated at regular time intervals (f.i. every six months, one or two years, etc.). A flow chart of the proposed characterization method **in the case of CT** is shown in Fig. 5a. The characterization is performed in the whole operating amplitude range suggested by standards [18]-[19], i.e. in the range 5 %-120 % of rated current (I_{pr}) for CTs (80 %-120 % of rated voltage for VTs). Moreover, the burden is varied from the rated value to a condition with a burden equal to that of the measurement circuit input impedance, which often corresponds to the open circuit condition for VT and short circuit for CT. For each selected amplitude and burden, a sinusoidal test is performed. The phasors at each harmonic frequency ($\bar{I}_{s,h}^{sin}$) are extracted and stored in a look-up table indexed by amplitude (I_p) and burden values. **Dual procedure applies for VT**

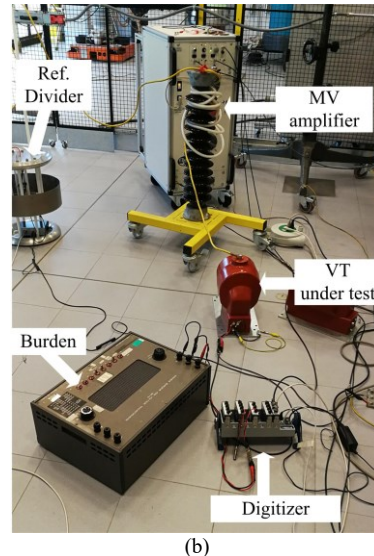
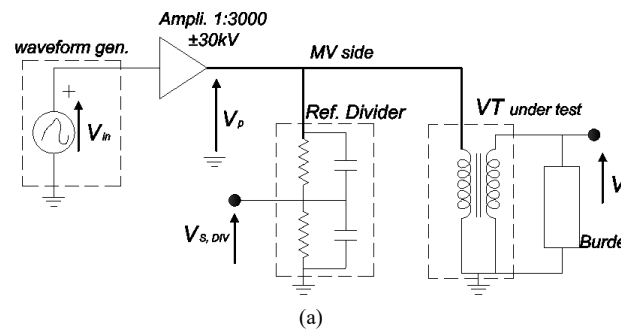

Fig. 4. Setup for the VT characterization: (a) Single line diagram, (b) Picture of experimental test bench at INRIM.

characterization.

The amplitudes and phases of harmonic phasors, measured with a sinusoidal input, are features characterizing the considered IT and they can be considered a comprehensive assessment of IT metrological performance in distorted conditions, as they are invariant with signal input waveform. So, their knowledge allows to quantify deviation in amplitude and phase (ratio and phase errors) due to core non linearity that apply in whatever working condition, allowing the compensation of harmonic deviations due to non-linearity.

C. Compensation Procedure

The compensation procedure (COMP) is the second step of the proposed technique and it is applied in every actual harmonic measurement done with the considered IT. A flow chart of the compensation method in the case of CT is shown in Fig. 5b. In detail, when a distorted waveform is applied to the IT, all the harmonic phasors (including the fundamental) of interest ($\bar{I}_{s,h}^d$) are extracted from the acquired signal at the secondary winding. The fundamental amplitude is used to select the harmonic phasor values ($\bar{I}_{s,h}^{sin}$) from the stored look up table **built in the first step**. Then the measured harmonic phasors ($\bar{I}_{s,h}^d$) are compensated by using (7) and (9). Finally, ratio and phase errors after compensation are evaluated by using (4) and (5).

The application of the proposed VT and CT characterization method and then the compensation procedure is referred to as SINDICOMP, that stands for VT and CT SINusoidal

characterization for DIstortion COMPensation.

V. EXPERIMENTAL RESULTS

A. CT and VT under test

The tested CT is a window type, openable core current transformer with rated ratio of 500 / 5 A/A, class 0.5, rated burden of 2.5 VA. For the case at hand, 40 additional turns have been realized on the primary side and the 20 A reference shunt has been used. This was made in order to assimilate the CT performance obtained with 40 turns and 12.5 A, to those obtainable with just one turn and 500 A. The 40 cables were wounded in a compact group and the diameter of each turn was very large with respect to the CT window area diameter, thus obtaining magnetic effects very similar to those of a 500 A current flowing in a straight single cable perpendicular to the CT core section. As for the burden, in one case the CT output current has been directly acquired with the comparator (using the NI 9227 module): its current terminals have an input impedance of about 12 m Ω , which corresponds to a burden of about 12 % of the rated value. In a second case, a pure resistor has been inserted at the CT secondary winding in series with the comparator, in order to reach a series resistance equal to 0.1 Ω , which corresponds to the 100 % of the rated burden.

The VT considered for this analysis is a commercial resin insulated VT for medium voltage phase-to-ground measurement application. The VT main features are: 1) rated primary voltage 20/ $\sqrt{3}$ kV, 2) rated secondary voltage 100/ $\sqrt{3}$ V, 3) rated frequency 50 Hz, 4) rated burden 50 VA, 5) accuracy class 0.5. The VT has been tested in two conditions: in the first one the VT output has been directly acquired with the comparator (using the NI 9225 module), which corresponds to a zero burden. In the second condition a standard 50 VA burden has been inserted in parallel between the VT secondary winding and the comparator input, which corresponds to the 100 % of the rated burden.

B. Experimental tests with two tones signals

First of all, the used CT and VT have been preliminarily characterized using SINDICOMP (see Sec. IV.B) and proper look-up tables have been constructed.

To validate the proposed techniques, two types of test were performed. The first test is the same proposed in [34] and [37], i.e. using a primary distorted waveform composed of a fundamental and a harmonic component.

In particular, waveforms composed by a fundamental tone at 48 Hz, 120 % of rated primary quantity and a single harmonic tone with fixed amplitude of 1 % of fundamental and variable harmonic order, from 2nd to 7th, and phase angle, from $-\pi$ to π , have been used both for CT and VT.

They have been also tested in two burden conditions, as previously described. Moreover, the performances have been evaluated **without and with the application of SINDICOMP** (see Sec. IV.C) in all the test conditions.

Results obtained with reference to the third harmonic component are shown in figures from 6 to 9 for the CT and in figures from 10 to 13 for the VT. Limits correspondent to a 0.5

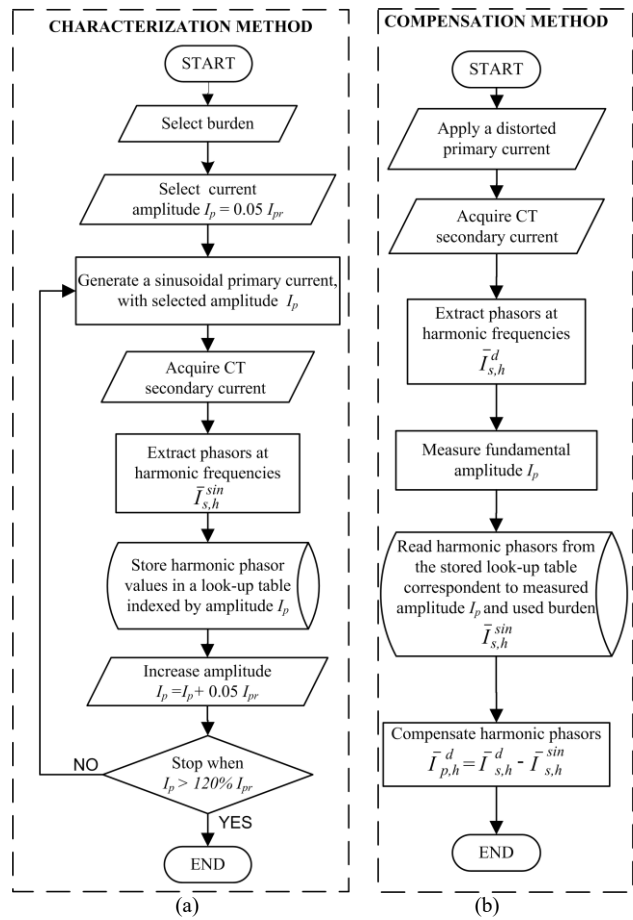

Fig. 5. Flow charts: (a) characterization method and (b) compensation procedure.

accuracy class are also shown.

Looking, for instance, at Fig. 6, which shows the CT ratio error with 12 % burden, the quasi sinusoidal behavior, from about -1 % to 1 %, is considerably reduced in amplitude, of about a factor 10, by using SINDICOMP. Similar improvements can be observed in all the figures from 6 to 13, that is both for CT and VT, for ratio error and phase error and with and without burden.

With the use of SINDICOMP, CT maximum ratio error with 12 % burden (Fig. 6) reduces from about 1.1 % down to about 0.08 %, while with 100 % burden (Fig. 7) from about 1.4 % down to about 0.06 %.

CT maximum phase error with 12 % burden (Fig. 8) reduces from about 12 mrad down to about 1.9 mrad, while with 100 % burden (Fig. 9) from about 15 mrad down to about 2.7 mrad.

It can also be seen that the presence of the burden slightly worsens the performance of CT, in terms of both ratio as well as phase errors at the third harmonic.

VT maximum ratio error with 0 % burden (Fig. 10) reduces from about 1.7 % down to about 0.4 %, while with 100 % burden (Fig. 11) from about 1.2 % down to about 0.06 %.

VT maximum phase error with 0 % burden (Fig. 12) reduces from about 13 mrad down to about 0.7 mrad, while with 100 % burden (Fig. 13) from about 11.5 mrad down to about 0.4 mrad.

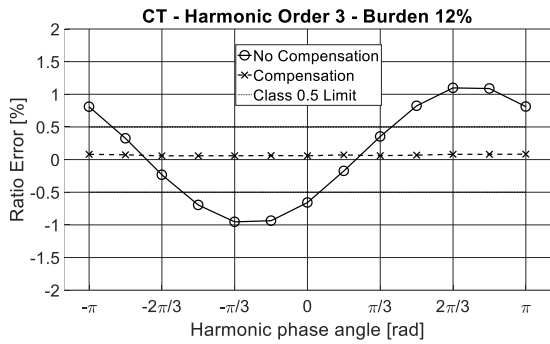

Fig. 6. Ratio error of the CT, with fundamental component of 120 %, third harmonic of 1 %, burden 12 %, with and without compensation

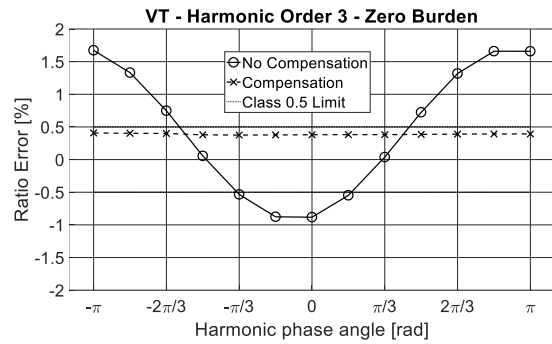

Fig. 10. Ratio error of the VT, with fundamental component of 120 %, third harmonic of 1 %, zero burden, with and without compensation

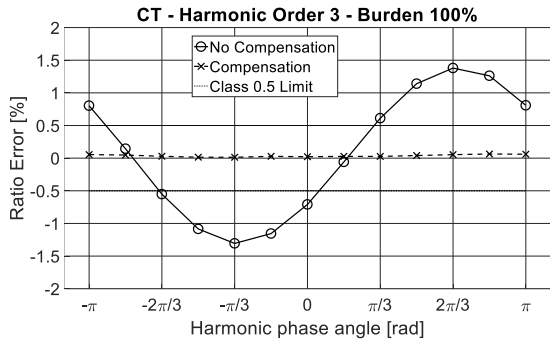

Fig. 7. Ratio error of the CT, with fundamental component of 120 %, third harmonic of 1 %, burden 100 %, with and without compensation

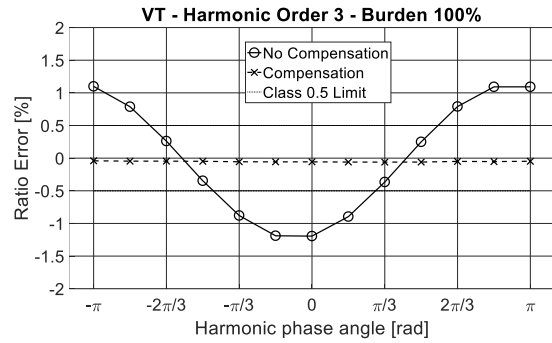

Fig. 11. Ratio error of the VT, with fundamental component of 120 %, third harmonic of 1 %, burden 100 %, with and without compensation

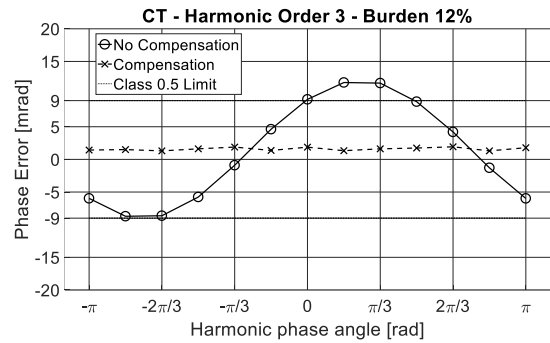

Fig. 8. Phase error of the CT, with fundamental component of 120 %, third harmonic of 1 %, burden 12 %, with and without compensation

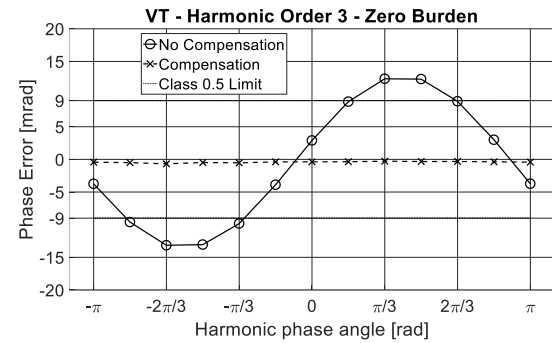

Fig. 12. Phase error of the VT, with fundamental component of 120 %, third harmonic of 1 %, zero burden, with and without compensation

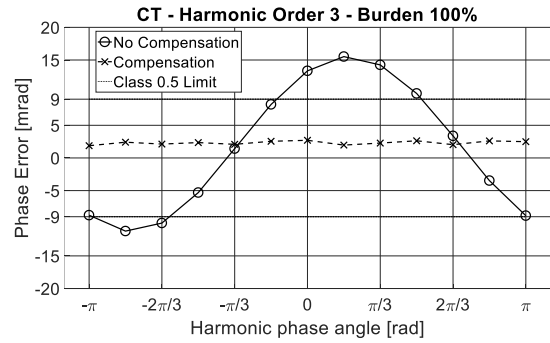

Fig. 9. Phase error of the CT, with fundamental component of 120 %, third harmonic of 1 %, burden 100 %, with and without compensation

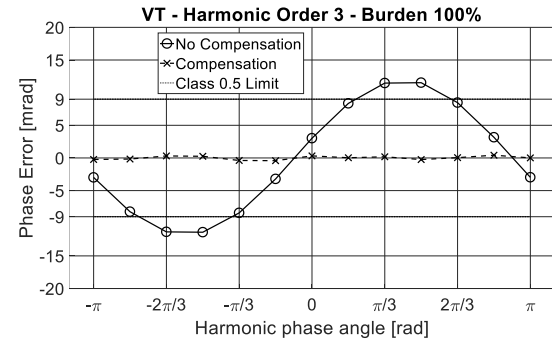

Fig. 13. Phase error of the VT, with fundamental component of 120 %, third harmonic of 1 %, burden 100 %, with and without compensation

Differently from CT, the presence of the burden slightly improves the performance of VT, in terms of both ratio as well as phase errors at third harmonic.

The results of the first test at all the harmonics from 2nd to 7th order are reported in Table I. In particular, the CT and VT maximum ratio and phase errors at all the tested harmonics, with and without compensation and with and without burden are reported. Moreover, also the expanded uncertainty (level of confidence 99 %) is shown.

Compensated ratio and phase errors are always better than the corresponding uncompensated values. The compensation greatly improves the performance at third harmonic and, in general, at odd harmonics. Lower improvements can be observed for even harmonics and, in general, when the uncompensated errors have low values (compared to the accuracy class). It is worth to emphasize that in all the cases, the expanded uncertainty is always lower than the measured errors, proofing the effectiveness of the proposed compensation.

C. Experimental tests with seven tones signals

A second test was performed to show the compensation performances when a more complex distorted primary waveform is used. For sake of brevity, only results relative to CT, with burden of 12 %, are here shown. More in details, a waveform composed by: 1) a fundamental tone at 48 Hz and 120 % of rated current; 2) all the harmonic components from the 2nd to 7th order having amplitude of 1% of fundamental tone and zero phase angle.

Ratio and phase errors have been measured without and with **SINDICOMP**. Results are shown in Table II.

Ratio and phase errors are always better for the compensated CT. A significant improvement is obtained especially for ratio error. Over 6th harmonic component, the compensation is still effective but the CT errors are quite small, yet.

Comparing the results of Table I and Table II, similar performance improvements can be found. This means that the proposed simplified theoretical model and, therefore, the compensation method are generally valid, even with the contemporary presence of several harmonic components.

TABLE. I.

ABSOLUTE VALUES OF MAXIMUM RATIO AND PHASE ERRORS OF CT AND VT, WITH AND WITHOUT COMPENSATION, AT EACH HARMONIC FREQUENCY IN THE TESTS WITH WAVEFORMS COMPOSED BY FUNDAMENTAL TONE AND ONE HARMONIC COMPONENT AND WITH AND WITHOUT BURDEN

				Harmonic Order					
				2	3	4	5	6	7
CT	Burden 12 %	Max Ratio Error [%]	Uncompensated	0.755	1.098	0.111	0.159	0.061	0.066
			Compensated	0.089	0.083	0.072	0.065	0.057	0.057
			Expanded Uncertainty (99 %)	0.014	0.014	0.013	0.014	0.014	0.012
		Max Phase Error [mrad]	Uncompensated	9.78	11.77	1.25	1.29	0.29	0.69
			Compensated	3.29	1.93	0.90	0.37	0.20	0.30
			Expanded Uncertainty (99 %)	0.13	0.14	0.14	0.15	0.15	0.12
	Burden 100%	Max Ratio Error [%]	Uncompensated	0.903	1.380	0.095	0.191	0.040	0.084
			Compensated	0.060	0.064	0.052	0.154	0.037	0.042
			Expanded Uncertainty (99 %)	0.012	0.013	0.011	0.012	0.012	0.014
		Max Phase Error [mrad]	Uncompensated	12.40	15.52	1.97	2.32	0.42	0.53
			Compensated	4.02	2.70	1.51	1.05	0.31	0.14
			Expanded Uncertainty (99 %)	0.14	0.12	0.14	0.13	0.13	0.15
VT	Burden 0 %	Max Ratio Error [%]	Uncompensated	0.869	1.674	0.514	0.540	0.440	0.452
			Compensated	0.472	0.408	0.447	0.410	0.379	0.350
			Expanded Uncertainty (99 %)	0.012	0.010	0.011	0.011	0.012	0.011
		Max Phase Error [mrad]	Uncompensated	4.04	13.16	1.72	2.74	1.68	2.77
			Compensated	1.28	0.68	1.10	1.56	1.32	1.70
			Expanded Uncertainty (99 %)	0.14	0.13	0.14	0.15	0.14	0.13
	Burden 100%	Max Ratio Error [%]	Uncompensated	0.418	1.194	0.104	0.195	0.089	0.221
			Compensated	0.075	0.061	0.064	0.070	0.083	0.087
			Expanded Uncertainty (99 %)	0.012	0.010	0.011	0.011	0.012	0.011
		Max Phase Error [mrad]	Uncompensated	2.51	11.53	0.57	2.18	1.18	2.63
			Compensated	0.95	0.42	0.48	0.55	0.59	0.58
			Expanded Uncertainty (99 %)	0.14	0.13	0.14	0.15	0.14	0.13

TABLE II.
CT RATIO AND PHASE ERRORS, WITH AND WITHOUT COMPENSATION, AT EACH HARMONIC FREQUENCY IN THE TEST WITH AN INPUT WAVEFORM CONTAINING ALL THE CONSIDERED HARMONIC COMPONENTS

		Harmonic Order					
		2	3	4	5	6	7
Ratio Error [%]	Uncompensated	-0.512	-0.726	-0.013	-0.101	0.053	0.045
	Compensated	-0.259	-0.035	-0.005	0.022	0.041	0.024
Phase Error [mrad]	Uncompensated	3.031	0.008	1.469	0.921	-0.740	-0.899
	Compensated	2.791	0.002	0.637	0.324	-0.552	-0.905

VI. CONCLUSION

In this paper the problem of harmonics measurement by means of Voltage and Current Instrument Transformer was faced. It was shown that, due to their intrinsic non linearity, remarkable errors are introduced in the measurement of harmonic components.

A simplified theoretical model for the non-linearity is proposed, which relates the non-linearity at harmonic frequencies to the fundamental amplitude. Thus, a very simple procedure for CTs and VTs non-linearity characterization and compensation is presented; **it is called SINDICOMP**.

SINDICOMP was validated testing two instrument transformers, by using distorted waveforms with different harmonic content, and varying the secondary burden. Experimental results showed the performance improvement obtained with the proposed compensation procedure.

A key feature of the proposed method is that it is very simple: **its computational load is very low since, for every harmonic of interest, it consists just in a memory access, to retrieve the phasor, and a summation between two phasors**. Therefore, it can be easily implemented also on low cost instruments, **typically characterized by low computational performances**, thus improving their **accuracy** in harmonic measurement.

REFERENCES

- [1] S. Elphick, V. Gosbell, V. Smith, S. Perera, P. Ciufu, G. Drury, "Methods for Harmonic Analysis and Reporting in Future Grid Applications", (2017) IEEE Trans. Power Del., 32 (2), pp. 989-995.
- [2] D. Carta, C. Muscas, P. A. Pegoraro, S. Sulis, "Identification and Estimation of Harmonic Sources Based on Compressive Sensing", IEEE Trans. Instrum. Meas., doi: 10.1109/TIM.2018.2838738.
- [3] X. Liang, C. Andalib-Bin-Karim, "Harmonics and Mitigation Techniques through Advanced Control in Grid-Connected Renewable Energy Sources: A Review", (2018) IEEE Trans. Ind. Appl., Article in Press.
- [4] A. Kalair, N. Abas, A. R. Kalair, Z. Saleem, N. Khan, "Review of harmonic analysis, modeling and mitigation techniques", Renewable and Sustainable Energy Reviews, vol. 78, pp. 1152-1187, Oct. 2017.
- [5] D. Vieira, R. A. Shayani, M. A. G. De Oliveira, "Reactive Power Billing under Nonsinusoidal Conditions for Low-Voltage Systems", IEEE Trans. on Instrum. Meas., vol. 66 no. 8, pp. 2004-2011, Aug. 2017.
- [6] G. Crotti, D. Giordano, "Set up and characterization of a measuring system for PQ measurements in a MV site with PV generation", (2015) Acta IMEKO, 4 (1), pp. 97-104.
- [7] Y. Naderi, et al., "An overview of power quality enhancement techniques applied to distributed generation in electrical distribution networks", (2018) Ren. Sust. Energy Rev., 93, pp. 201-214.
- [8] Electromagnetic Compatibility (EMC) Part 4-30: 'Testing and Measurement Techniques—Power Quality Measurement Methods.' IEC 61000-4-30, 2003 ed., Oct. 13, 2008.
- [9] Electromagnetic Compatibility (EMC) Part 4-7: "Testing and measurement techniques – General guide on harmonics and interharmonics measurements and instrumentation, for power supply systems and equipment connected thereto". IEC 61000-4-7 Ed.2008.
- [10] G. Pasini, L. Peretto, P. Roccatò, A. Sardi and R. Tinarelli, "Traceability of Low-Power Voltage Transformer for Medium Voltage Application," in IEEE Transactions on Instrumentation and Measurement, vol. 63, no. 12, pp. 2804-2812, Dec. 2014.
- [11] A. Cataliotti, D. Di Cara, A. E. Emanuel, S. Nuccio, "Improvement of Hall Effect Current Transducer Metrological Performances in the Presence of Harmonic Distortion," IEEE Trans. on Instrumentation and Measurement, vol. 59, no. 5, May 2010, pp. 1091-97.
- [12] E. Mohns, G. Roeissle, S. Fricke and F. Pauling, "An AC Current Transformer Standard Measuring System for Power Frequencies," in IEEE Transactions on Instrumentation and Measurement, vol. 66, no. 6, pp. 1433-1440, June 2017.
- [13] R. Stiegler, J. Meyer, J. Kilter and S. Konzelmann, "Assessment of voltage instrument transformers accuracy for harmonic measurements in transmission systems," 2016 17th International Conference on Harmonics and Quality of Power (ICHQP), Belo Horizonte, 2016, pp. 152-157.
- [14] A. Cataliotti, V. Cosentino, D. Di Cara, S. Nuccio, G. Tinè, "Rogowski coil current transducer compensation method for harmonic active power error", Measurement, vol. 63, Mar. 2015, pp. 240–251.
- [15] C. Muscas, L. Peretto, R. Sasdelli and A. Briani, "An automatic test equipment for the calibration of voltage transducers," in IEEE Transactions on Instrumentation and Measurement, vol. 50, no. 6, pp. 1638-1643, Dec 2001.
- [16] Instrument Transformers—The Use of Instrument Transformers for Power Quality Measurement, document Rec. IEC/TR 61869-103, 2012.
- [17] Instrument transformers - Part 8: Electronic current transformers, IEC 60044-8 (2002).
- [18] Instrument transformers - Part 2: Additional requirements for current transformers IEC 61869-2 (2012).
- [19] Instrument transformers - Part 3: Additional requirements for inductive voltage transformers, IEC 61869-3 (2011).
- [20] **IEEE Standard Requirements for Instrument Transformers," in IEEE Std C57.13-2016 (Revision of IEEE Std C57.13-2008) , pp.1-96, 29 June 2016.**
- [21] **IEEE Standard for High-Accuracy Instrument Transformers," in IEEE Std C57.13.6-2005 , pp. 1-6, 2005.**
- [22] **Instrument transformers - Part 6: Additional general requirements for low-power instrument transformers. IEC 61869-6 (2016)**
- [23] **Instrument transformers - Part 10: Additional requirements for low-power passive current transformers, IEC 61869-10 (2017).**
- [24] **Instrument transformers - Part 11: Additional requirements for low power passive voltage transformers, IEC 61869-11 (2017).**
- [25] M. Faifer, C. Laurano, R. Ottoboni, S. Toscani, M. Zanoni, "Characterization of Voltage Instrument Transformers Under Nonsinusoidal Conditions Based on the Best Linear Approximation", in IEEE Transactions on Instrumentation and Measurement. doi: 10.1109/TIM.2018.2806949.
- [26] M. Faifer; R. Ottoboni; S. Toscani, C. Cherbaucich; P. Mazza "Metrological Characterization of a Signal Generator for the Testing of Medium-Voltage Measurement Transducers", IEEE Trans. Instrum. Measur., Vol. 64, no: 7, July 2015, pp. 1837-1846.

- [27] G. Crotti, D. Gallo, D. Giordano, C. Landi, M. Luiso and M. Modarres, "Frequency Response of MV Voltage Transformer Under Actual Waveforms," in *IEEE Transactions on Instrumentation and Measurement*, vol. 66, no. 6, pp. 1146-1154, June 2017
- [28] G. Crotti; D. Gallo; D. Giordano; C. Landi; M. Luiso; M. Modarres; M. Zucca, "Frequency Compliance of MV Voltage Sensors for Smart Grid Application," *IEEE Sensors Journal*, vol. 17, no. 23, pp. 7621-7629, Dec.1, 1 2017.
- [29] D. Slomovitz, "Electronic system for increasing the accuracy of in-service instrument-current transformers," *IEEE Trans. Instrumentation and Measurement*, vol. 52, pp. 408-410, Apr. 2003.
- [30] A. Baccigalupi and A. Liccardo, "Low-cost prototype for the electronically compensation of current transformers," *IEEE Sensors Journal*, vol. 9, pp. 641-647, June 2009.
- [31] D. Slomovitz and A. Santos, "A self-calibrating instrument current transformer," *Measurement*, vol. 45, pp. 2213-2217, 2012.
- [32] N. Locci and C. Muscas, "Hysteresis and eddy currents compensation in current transformers," in *IEEE Transactions on Power Delivery*, vol. 16, no. 2, pp. 154-159, Apr 2001.
- [33] Y. C. Kang, T. Y. Zheng, Y. H. Kim, B. E. Lee, S. H. So, and P. A. Crossley, "Development of a compensation algorithm for a measurement current transformer," *IET Generation, Transmission & Distribution*, vol. 5, pp. 531-539, May 2011.
- [34] A. Cataliotti, D. Di Cara, A. E. Emanuel, S. Nuccio, "A Novel Approach to Current Transformer Characterization in the Presence of Harmonic Distortion," *IEEE Transactions on Instrumentation and Measurement*, vol. 58, no. 5, pp. 1446-1453, May 2009.
- [35] A. Cataliotti, D. Di Cara, A. E. Emanuel, S. Nuccio, "Characterization of Clamp-on Current Transformers under Nonsinusoidal Conditions," *IEEE Trans. on Power Delivery*, vol. 24, no. 1, pp. 373-380, Jan. 2009.
- [36] A. Cataliotti, D. Di Cara, A. E. Emanuel, S. Nuccio, "Current Transformers Effects on the Measurement of Harmonic Active Power in LV and MV Networks," *IEEE Transactions on Power Delivery*, vol. 26, no. 1, pp. 360-368, Jan. 2011.
- [37] A. Cataliotti et al., "Metrological performances of voltage and current instrument transformers in harmonics measurements," 2018 IEEE International Instrumentation and Measurement Technology Conference (I2MTC), Houston, TX, 2018, pp. 1366 - 1371
- [38] G. Crotti; D. Gallo; D. Giordano; C. Landi; M. Luiso, "Industrial Comparator for Smart Grid Sensor Calibration," in *IEEE Sensors Journal*, vol. 17, no. 23, pp. 7784-7793, Dec.1, 1 2017.
- [39] M. Zucca, M. Modarres, D. Giordano and G. Crotti, "Accurate Numerical Modelling of MV and HV Resistive Dividers," in *IEEE Trans. on Power Delivery*, vol. 32, no. 3, pp. 1645-1652, June 2017