



ISTITUTO NAZIONALE DI RICERCA METROLOGICA Repository Istituzionale

Intercontinental comparison of optical atomic clocks through very long baseline interferometry

This is the author's accepted version of the contribution published as:

Original

Intercontinental comparison of optical atomic clocks through very long baseline interferometry / Pizzocaro, Marco; Sekido, Mamoru; Takefuji, Kazuhiro; Ujihara, Hideki; Hachisu, Hidekazu; Nemitz, Nils; Tsutsumi, Masanori; Kondo, Tetsuro; Kawai, Eiji; Ichikawa, Ryuichi; Namba, Kunitaka; Okamoto, Yoshihiro; Takahashi, Rumi; Komuro, Junichi; Clivati, Cecilia; Bregolin, Filippo; Barbieri, Piero; Mura, Alberto; Cantoni, Elena; Cerretto, Giancarlo; Levi, Filippo; Maccaferri, Giuseppe; Roma, Mauro; Bortolotti, Claudio; Negusini, Marco; Ricci, Roberto; Zacchiroli, Giampaolo; Roda, Juri; Leute, Julia; Petit, Gérard; Perini, Federico; Chiovetti, Davide; DiLabate, Tetsuya; *et al.* - (2021). [10.1038/s41567-020-01038-6] *Applied Physics Letters*, 119(12), 124101. ISSN 1071-7014.

Publisher:

Nature publishing group

Published

DOI:10.1038/s41567-020-01038-6

Terms of use:

This article is made available under terms and conditions as specified in the corresponding bibliographic description in the repository

Publisher copyright

(Article begins on next page)

Intercontinental comparison of optical atomic clocks via very long baseline interferometry

Marco Pizzocaro^{1*}, Mamoru Sekido^{2*}, Kazuhiro Takefuji^{2,†}
Hideki Ujihara², Hidekazu Hachisu³, Nils Nemitz³,
Masanori Tsutsumi³, Tetsuro Kondo^{2,4}, Eiji Kawai²,
Ryuichi Ichikawa³, Kunitaka Namba³, Yoshihiro Okamoto³,
Rumi Takahashi³, Junichi Komuro³, Cecilia Clivati¹,
Filippo Bregolin¹, Piero Barbieri¹, Alberto Mura¹,
Elena Cantoni¹, Giancarlo Cerretto¹, Filippo Levi¹,
Giuseppe Maccaferri⁵, Mauro Roma⁵, Claudio Bortolotti⁵,
Monia Negusini⁵, Roberto Ricci^{1,5}, Giampaolo Zacchioli⁵,
Juri Roda⁵, Julia Leute^{6,7}, Gérard Petit⁶, Federico Perini⁵,
Davide Calonico¹, Tetsuya Ido³

¹Istituto Nazionale di Ricerca Metrologica (INRIM), Torino, Italy.

²National Institute of Information and Communications Technology (NICT), Kashima, Japan.

³National Institute of Information and Communications Technology (NICT), Koganei, Tokyo, Japan.

⁴Chinese Academy of Sciences, Shanghai Astronomical Observatory, China.

⁵Istituto Nazionale di Astrofisica (INAF), Istituto di Radioastronomia (IRA), Bologna, Italy.

⁶Bureau International des Poids et Mesures (BIPM), Sèvres, France.

⁷LNE-SYRTE, Observatoire de Paris, Université PSL, CNRS, Sorbonne Université, Paris, France.

*Corresponding authors. Email: m.pizzocaro@inrim.it, sekido@nict.go.jp

†Present address: Japan Aerospace Exploration Agency (JAXA), Nagano, Japan.

ACCEPTED MANUSCRIPT

published as:

Pizzocaro, M., Sekido, M., Takefuji, K. et al.

Intercontinental comparison of optical atomic clocks through very long baseline interferometry. Nat. Phys. (2020).

<https://doi.org/10.1038/s41567-020-01038-6>

<https://www.nature.com/articles/s41567-020-01038-6>

1 **The comparison of distant atomic clocks is foundational**
2 **to international timekeeping, global positioning and tests**
3 **of fundamental physics. Optical fibre links allow the**
4 **best optical clocks to be compared without degradation**
5 **over distances up to thousands of kilometres, but in-**
6 **tercontinental comparisons remain limited by the per-**
7 **formance of satellite transfer techniques. Here we show**
8 **that very long baseline interferometry (VLBI), although**
9 **originally developed for radio astronomy and geodesy,**
10 **can overcome this limit and compare remote clocks through**
11 **observing extragalactic radio sources. We developed**
12 **dedicated transportable VLBI stations that use broad-**
13 **band detection and we compared two optical clocks in**
14 **Italy and Japan separated by 9000 km. This system**
15 **demonstrates performance beyond satellite techniques**
16 **and can pave the way for future long-term stable inter-**
17 **national clock comparisons.**

18 Atomic clocks based on optical transitions can reach fractional uncer-
19 tainties at the 10^{-18} level¹⁻³ surpassing by two orders of magnitude the
20 microwave clocks⁴ that realize the definition of the second in the Interna-
21 tional System of Units (SI) and are the basis of international timekeep-
22 ing⁵. Given the rapid progress of optical clocks, a redefinition of the SI
23 second as the unit of time is anticipated⁶. The remote comparison of dif-
24 ferent clocks worldwide is fundamental to check their consistency in view of
25 such a redefinition. It is also attractive for challenging experiments such as
26 tests of special and general relativity⁷⁻⁹, laboratory searches for the vari-
27 ations of fundamental constants^{10,11}, and measurements of Earth's grav-
28 itational potential¹²⁻¹⁴. Future applications of clock comparisons include
29 the search for dark matter¹⁵, the establishment of quantum networks for
30 secure communications and timing¹⁶ and gravitational wave detection¹⁷.
31 Optical fibre links have been shown to allow comparisons at the full accu-
32 racy of the clocks up to thousands of kilometres¹⁸. However, they have not
33 reached a transoceanic scale¹⁹ and therefore intercontinental comparisons
34 are only possible by microwave satellite transfer techniques²⁰. Among these
35 are two-way time-and-frequency transfer, which makes use of geostationary
36 telecommunication satellites^{21,22}, or precise point positioning²³, which relies
37 on the constellation of the Global Positioning System (GPS). These tech-
38 niques achieve a typical uncertainty at the level of 10^{-15} at 1 d of averaging
39 time that limits the comparison of optical clocks.

40 Very long baseline interferometry (VLBI) is a technique developed for
41 radio astronomy and geodesy^{24,25} based on the simultaneous observation
42 of remote radio sources with distant antennas, each referenced to a local
43 atomic clock. Since its early development, VLBI has been considered for

1 synchronization of the reference clocks^{26,27} but it has never been exploited
 2 for this task due to the convenient use of satellites. Recently, VLBI has
 3 been proposed to improve intercontinental frequency links²⁸ and has been
 4 suggested for the comparison of optical clocks²⁹. Here we demonstrate a
 5 VLBI system dedicated to frequency transfer with broadband detection that
 6 allows for better performance than satellite techniques.

7 VLBI cross-correlates the signals arriving from astronomical radio sources
 8 to different antenna locations. The geometrical delay between two stations
 9 $\tau_{\text{geom}} = \mathbf{B} \cdot \mathbf{S}/c$ depends on the baseline between the antennas \mathbf{B} and
 10 the unit vector to the radio source \mathbf{S} , with c the speed of light. The ob-
 11 served value τ_{obs} differs from the geometrical delay because of the timing
 12 offset between the reference clocks $\Delta\tau_{\text{clock}}$ and it is additionally affected by
 13 the station-to-station difference in excess delays introduced by atmosphere
 14 $\Delta\tau_{\text{atm}}$, ionosphere $\Delta\tau_{\text{ion}}$, instruments such as antennas, cables, and receivers
 15 $\Delta\tau_{\text{instr}}$, and ultimately the radio source structure $\Delta\tau_{\text{source}}$:

$$\tau_{\text{obs}} = \tau_{\text{geom}} + \Delta\tau_{\text{atm}} + \Delta\tau_{\text{ion}} + \Delta\tau_{\text{instr}} + \Delta\tau_{\text{source}} + \Delta\tau_{\text{clock}}. \quad (1)$$

16 The different components of the delay can be either modelled, estimated
 17 from the observations, or obtained as a result of separate measurements
 18 depending on the application. Radio astronomy is interested in studying
 19 radio source structure while geodetic VLBI seeks to minimize its effects by
 20 selecting point-like sources in the interest of determining precise station co-
 21 ordinates and monitoring variations in Earth rotation. The International
 22 Celestial Reference Frame (ICRF) as adopted by the International Astro-
 23 nomical Union (IAU)³⁰ provides a suitable list of extragalactic radio sources
 24 that are regarded as fiducial points in the sky. Calibration of excess atmo-
 25 spheric delay is made by an atmospheric model based on weather data³¹,
 26 which is represented by a zenith delay and a mapping function for observa-
 27 tions at different elevation angles generated by ray tracing techniques. The
 28 ionospheric delay has a characteristic frequency dependence that allows its
 29 calibration directly from observation data. VLBI measurements typically
 30 use local active hydrogen masers as stable frequency references. When all
 31 effects are considered, it is possible for VLBI measurements to provide the
 32 frequency difference between the hydrogen masers and thus compare any
 33 clocks or timescales locally linked to them.

34 We designed and built two transportable VLBI stations with 2.4 m diam-
 35 eter Cassegrain antennas. These stations implement the concept of broad-
 36 band VLBI observation proposed as VLBI Global Observing System (VGOS)
 37 by the International VLBI Service for Geodesy and Astrometry (IVS)³² to
 38 reach 1 mm position accuracy in geodetic measurements. Whereas standard
 39 geodetic VLBI only makes observations in narrow frequency ranges in the
 40 S band (2.2 GHz–2.4 GHz) and X band (8.2 GHz–8.95 GHz)²⁵, the stations

1 in this work can access frequencies from 3 GHz to 14 GHz. Our receivers
2 first acquire data with a sampling rate of 16 GHz and then digital filters
3 extract the signals in four 1 GHz wide channels spread over the wide fre-
4 quency range. Integration of the four channels determines precise group
5 delays using the bandwidth synthesis technique³³. We employ a 2048 MHz
6 sampling rate in each channel, where conventional VLBI uses 32 MHz or
7 below, enhancing the signal-to-noise ratio by a factor of 8. Improved signal-
8 to-noise ratio allows for smaller overall dish area of the antennas. By itself,
9 the enhanced detection bandwidth is not sufficient for measurements over an
10 intercontinental baseline with easily transportable dish sizes. This is over-
11 come by including the 34 m radio antenna operated by NICT in Kashima
12 (Japan) in a joint node-hub style observation: the delay observable between
13 the transportable stations (nodes) can be calculated as the difference of the
14 two delays with the large antenna (hub) after applying a small correction
15 factor (see Methods). This measurement benefits from the improvement of
16 the equivalent dish area, which scales as the geometrical mean, without the
17 penalties specific to large antennas since the delay variations due to gravita-
18 tional distortion of the large dish or temperature dependence in long cables
19 are largely reduced as a common-mode noise.

20 Here, one node was installed at NICT headquarters in Koganei (Japan)
21 while the other was transported to the Radio Astronomical Observatory op-
22 erated by INAF in Medicina (Italy), forming an intercontinental baseline
23 of 8700 km (see Fig. 1). Observation data at Medicina and Koganei were
24 stored on hard-disk drives at each station and transferred over high-speed
25 Internet networks to the correlation center in Kashima for analysis. Ten
26 frequency measurements via VLBI were performed between October 2018
27 and February 2019 from which we calculated the frequency difference be-
28 tween the reference clocks at the two stations: the local hydrogen masers in
29 Medicina and in Koganei. Each session lasted from 28 h to 36 h and included
30 at least 400 scans observing between 16 and 25 radio sources in the ICRF
31 list. A least-squares fit of each run was used to calculate the observed delay
32 with typical residuals of 30 ps and a formal uncertainty in the frequency
33 comparison as low as 1.5×10^{-16} for a single run (see Extended Data Table
34 1). At this level of uncertainty, accurate modelling of atmospheric delays is
35 a crucial part of the analysis (see Methods).

36 We used this VLBI frequency link to compare two optical clocks: the
37 ytterbium-171 optical lattice clock³⁴ IT-Yb1 at INRIM in Torino (Italy)
38 and the strontium-87 optical lattice clock^{35,36} NICT-Sr1 in Koganei. Both
39 optical clocks are realizations of the unit of time, formally recognized within
40 the Metre Convention. This is possible because the frequency values of
41 ytterbium and strontium clock transitions are recommended as secondary
42 representations of the second in the list of standard reference frequency val-
43 ues^{6,37} of the International Committee for Weights and Measures (CIPM)
44 with frequencies $f(\text{Yb}) \approx 518 \text{ THz}$ and $f(\text{Sr}) \approx 429 \text{ THz}$ and with rela-

1 tive uncertainties of 5×10^{-16} and 4×10^{-16} respectively. Therefore, the
 2 frequency ratio between IT-Yb1 and NICT-Sr1 can be compared to the of-
 3 ficially recommended values in addition to previous measurements^{13,22,38,39}.

4 The frequency comparison between IT-Yb1 and NICT-Sr1 followed the
 5 chain shown in Fig. 1. In Torino, the ytterbium clock was compared to
 6 a local hydrogen maser using an optical frequency comb⁴⁰, which allows
 7 precise optical-to-microwave frequency comparisons. The comb in Torino
 8 also measured a narrow-linewidth laser at telecommunication wavelengths
 9 that was sent on a compensated optical fibre link⁴¹ of 535 km to the Radio
 10 Observatory in Medicina. Here, another optical frequency comb compared
 11 the laser fibre-delivered from Torino with the hydrogen maser referencing
 12 the VLBI station. In Koganei, a third optical frequency comb was used for
 13 the comparison of the strontium clock with local hydrogen masers, including
 14 the maser used as reference for the VLBI station.

15 Since the optical clocks, optical link and VLBI link operated intermit-
 16 tently throughout this campaign we extrapolate the hydrogen maser frequen-
 17 cies^{42,43} to calculate a frequency ratio for each VLBI run. Figure 2a shows
 18 the results of the ratio measurements, with uncertainties evaluated for each
 19 step of the frequency chain including the extrapolations (see Methods). The
 20 weighted mean for the campaign is the frequency ratio $R = f(\text{Yb})/f(\text{Sr}) =$
 21 $1.207\,507\,039\,343\,338\,05(34)$ measured via VLBI. This corresponds to a frac-
 22 tional deviation from the ratio R_0 of the recommended frequencies for ytter-
 23 bium and strontium of $y(\text{Yb}/\text{Sr}) = R/R_0 - 1 = 2.5(2.8) \times 10^{-16}$ in agreement
 24 with previous measurements (see Fig. 2b). Over the course of the campaign,
 25 the overall VLBI measurement contributes a one-standard-deviation uncer-
 26 tainty of only 9×10^{-17} for a total measurement time of 300 h. The optical
 27 link, conversion to microwave signals, maser frequency extrapolation and
 28 systematic effects in the optical clocks contribute to the overall uncertainty
 29 of 2.8×10^{-16} as reported in Table 1. The gravitational redshift induced by
 30 the different gravitational potential at the position of the optical clocks^{34,35}
 31 has been accounted for in the clock systematic shifts, bringing a relative
 32 correction of $-1.765(2) \times 10^{-14}$ to the frequency ratio.

33 To confirm the results, we established an independent frequency link
 34 using GPS satellites between receivers at INRIM and at NICT (see Fig.
 35 1). To achieve low uncertainty on this link, we calculated a precise point
 36 positioning solution with integer ambiguity resolution (IPPP)⁴⁴. For this
 37 baseline, IPPP has an uncertainty of 9×10^{-16} at 1 d of averaging time.
 38 The comparison of the ytterbium and strontium optical clocks using the
 39 IPPP solution over the same time intervals as the VLBI runs is also shown
 40 in Fig. 2a. The weighted mean of the frequency deviation of the ratio is
 41 $y(\text{Yb}/\text{Sr}) = -3.2(4.0) \times 10^{-16}$ measured via IPPP. As shown in Table 1, the
 42 GPS link contributes an overall uncertainty for the campaign of 2.6×10^{-16} .
 43 We can also compare the VLBI and IPPP results directly, closing the loop
 44 via the optical link, and the weighted mean of the differences for the entire

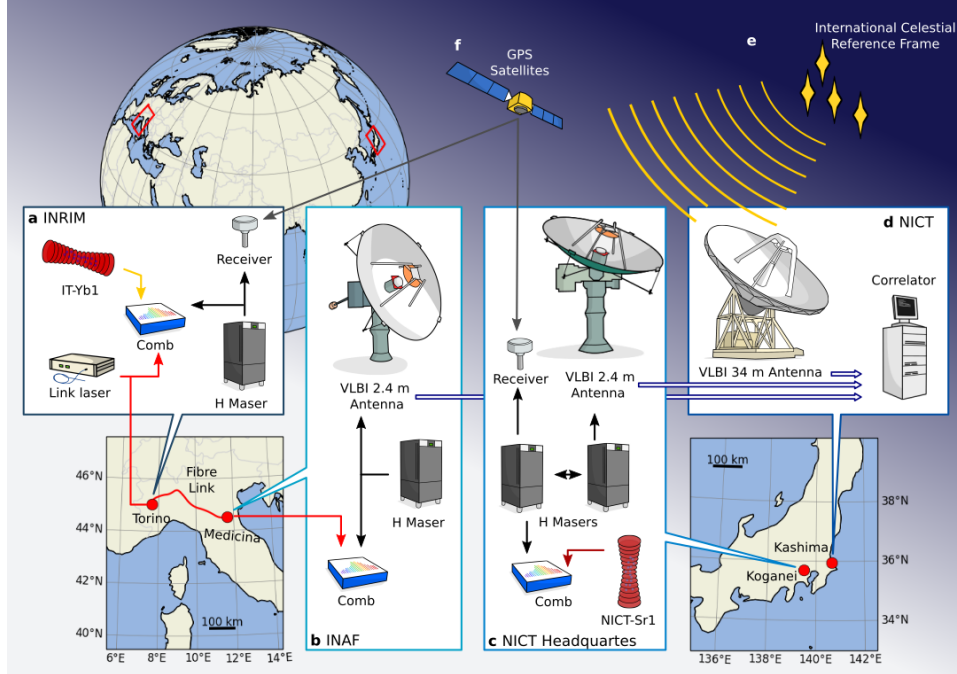

Figure 1: Schematic representation of the frequency link between the ytterbium and strontium optical clocks via VLBI and satellite transfer. **a**, In Torino, IT-Yb1 at INRIM is compared with the local hydrogen maser and the link laser using an optical frequency comb. The link laser is sent over compensated fibre link to Medicina. **b**, In Medicina, at INAF Radio Observatory, the incoming link laser is compared with the local hydrogen maser using another optical frequency comb. The first transportable broadband VLBI station is setup in Medicina and referenced to this maser. **c**, In Koganei, the second VLBI station at NICT headquarters is referenced to a local hydrogen maser. NICT-Sr1 is compared to the local hydrogen maser using a third optical frequency comb, ending the chain. **d**, The 34 m diameter radio telescope maintained by NICT in Kashima assisted in the node-hub style observations, increasing the signal-to-noise ratio. The observation data in Medicina and Koganei were transferred to the correlation center in Kashima over high-speed internet networks (blue arrows). The cross-correlation between the antennas and the following geodetic analysis allows to measure the reference clock difference. **e**, The VLBI link is established by observing several radio sources in the International Celestial Reference Frame. **f**, A satellite frequency link with GPS satellites is established between the receivers in Torino and Koganei.

Table 1: Uncertainty budgets for the ratio and closure measurements. The listed uncertainties are calculated for the weighted average of the points in Figure 2a and the weighted average of their difference. The VLBI and IPPP uncertainties are the statistical contribution for the frequency transfer. The clock contributions consist of the systematic uncertainties of both clocks, including the gravitational redshift. The extrapolation uncertainty is a statistical uncertainty due to the intermittent operations of the optical clocks and the optical link. The uncertainty for the combs arises from their accuracy and from the instability in the microwave to optical conversions. The optical link contribution is negligible for the present measurement. All uncertainties correspond to one standard deviation.

Yb/Sr ratio via VLBI		Yb/Sr ratio via IPPP		Closure	
Contribution	Uncer. ($\times 10^{-16}$)	Contribution	Uncer. ($\times 10^{-16}$)	Contribution	Uncer. ($\times 10^{-16}$)
VLBI	0.9	IPPP	2.6	VLBI	0.7
Clocks	0.9	Clocks	0.9	IPPP	2.3
Combs (microwave/optical)	1.1	Combs (microwave/optical)	1.1	Combs (microwave/optical)	1.1
Extrapolation	2.2	Extrapolation	2.6	Extrapolation	1.9
Optical link	<0.1			Optical link	<0.1
Total	2.8	Total	4.0	Total	3.2

1 campaign is $y(\text{VLBI-IPPP}) = 3.5(3.2) \times 10^{-16}$.

2 By leveraging broadband observations, our VLBI system surpasses the
3 best satellite techniques and what is possible with traditional geodetic VLBI,
4 resulting in a typical formal uncertainty of 2×10^{-16} at 10^5 s of averaging
5 time. It has the potential to reach uncertainty in the low 10^{-17} region at
6 10 d of averaging time provided variations in instrumentation delay are min-
7 imized, radio sources are carefully selected to minimize structure effects, and
8 the atmosphere is accurately modelled. Although VLBI still requires optical
9 to microwave conversions, this is an attractive technique for optical clocks
10 comparisons. With increased operational duty times of the optical clocks
11 and improved characterization of the combs⁴⁵ and of the frequency chains,
12 it will allow for link uncertainties that approach the systematic uncertainties
13 of optical clocks for manageable measurement times.

14 Our measurements show agreement between the VLBI link, the optical
15 clocks and the GPS link at the low 10^{-16} level. There is still some uncer-
16 tainty on the optimal treatment for the calibration of the tropospheric delay
17 in a VLBI experiment with a long single baseline and further investigation
18 should clarify the correlation with the estimated clock frequency. We have
19 estimated that thermal sensitivity of the cables and of the antennas con-
20 tributed an uncertainty less than 1×10^{-17} . The microwave signal acquired
21 by the antenna is transferred to the data acquisition system by amplitude

a

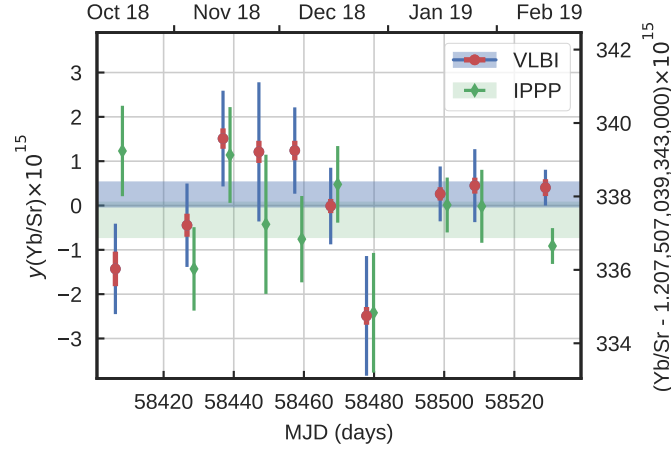

b

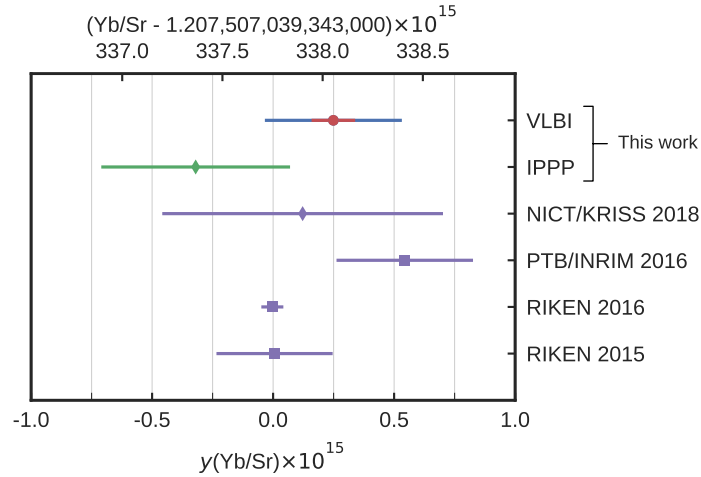

Figure 2: Comparison of Yb/Sr frequency ratio measurements. **a**, Ratio measurements for each VLBI run at a given Modified Julian Date (MJD) measured via VLBI or IPPP. Red bars represent the statistical uncertainty of the VLBI link only, while blue bars represent the total uncertainty for the VLBI comparisons (including optical clocks, optical combs, and extrapolations). Blue shaded region is the weighted mean of the VLBI comparison with its total uncertainty. Green points represent the IPPP comparisons with their total uncertainty. Green shaded region is the weighted mean of the IPPP comparison with its total uncertainty. Horizontal offset between the two dataset is for clarity. **b**, Optical frequency ratio $f(\text{Yb})/f(\text{Sr})$ as measured in this work (red/blue and green points as in a) or in previous measurements where purple squares represent local measurements at RIKEN^{38,39} and by PTB and INRIM¹³ and the purple diamond denotes a remote measurement performed by NICT and KRISS²². All uncertainties correspond to one standard deviation.

1 modulation of an infrared laser over fibre. In Medicina, a 600 m long under-
 2 ground fibre is used, with frequency shifts less than 8×10^{-17} in a day. In
 3 our experiment, we observed excess delay residuals for 3 of the 35 observed
 4 sources caused by the source structure effect^{46,47}. The increased residu-
 5 als are accounted for in the fit procedure but a careful selection of radio
 6 sources will help to avoid systematic effects in future clock comparisons. On
 7 the other hand, transportable broadband antennas may play a significant
 8 role to increase the density and extend the baselines in large networks of
 9 antennas, with the aim to improve investigations of source with structure.

10 The endpoint VLBI stations are transportable and can be deployed close
 11 to time-and-frequency laboratories just like traditional satellite antennas,
 12 supported by the node-hub topology. They can be operated without the
 13 need for a radio transmission license and, with a higher data transmission ca-
 14 pability, they may provide a continuous link instead of the separate sessions
 15 used in our measurements. Where laboratories lack the facilities or sky cov-
 16 erage to house a VLBI station, they can be connected by local optical fibre
 17 links, as demonstrated here. It is envisioned that optical clock comparisons
 18 will increasingly rely on local area fibre networks connected by non-fibre
 19 intercontinental links, with application in precision timing, searches for new
 20 physics and clock-based geodesy⁴⁸. Proposals for improved intercontinen-
 21 tal links includes IPPP⁴⁴, carrier-phase two way frequency transfer⁴⁹, and
 22 the use of transportable optical clocks¹³ or dedicated orbital systems such
 23 as the planned Atomic Clock Ensemble in Space (ACES) mission⁵⁰. Our
 24 experiment realizes such a hybrid network with a high performance VLBI
 25 link, useful for primary metrology and fundamental physics.

26 **Methods**

27 **Broadband VLBI observation system**

28 In VLBI observations, the standard deviation of the observed group delay
 29 is given by

$$\sigma_\tau = \frac{1}{2\pi R_{\text{sn}} \Delta f_{\text{rms}}}, \quad (2)$$

30 where Δf_{rms} is the root mean square deviation of the observation frequencies
 31 f_i while the signal to noise ratio is given by

$$R_{\text{sn}} = \eta \sqrt{\frac{A_1 A_2 B t}{T_1 T_2}} \frac{S}{2k_{\text{B}}}, \quad (3)$$

32 where A_j are the effective areas of the two antennas, T_j the system noise
 33 temperatures, B is the observation bandwidth, t is the integration time, S
 34 is correlated flux density of the radio source, k_{B} is Boltzmann's constant

1 and η is a digital processing loss factor⁵¹. Delay observations can thus be
2 improved by increasing the spread of observation frequency Δf_{rms} and the
3 bandwidth B of the observations.

4 The VLBI observation system used in this experiment, GALA-V⁵², im-
5 plements data acquisition according to the VGOS standard, which aims at
6 making broadband observations spread over the frequency range of 2 GHz–
7 14 GHz. NICT developed a unique broadband feed⁵³ named NINJA, with
8 constant narrow beam size for wide frequency range, which enables broad-
9 band observation with existing Cassegrain antennas. The NINJA broadband
10 feeds were installed in the two transportable 2.4 m diameter antennas and
11 the Kashima 34 m diameter antenna. The transportable antennas acquire a
12 single linear (V) polarization signal. To avoid a loss of correlation from the
13 different polarizations observed by distant stations due to parallactic angle,
14 the hub station in Kashima acquires both (V and H) polarizations. The VH
15 and VV data sets are then processed coherently.

16 The data-acquisition we adopted uses four channels with $B = 1024$ MHz
17 bandwidth at frequencies $f_1 = 6.0$ GHz, $f_2 = 8.5$ GHz, $f_3 = 10.4$ GHz and
18 $f_4 = 13.3$ GHz. This system is simpler than the prototype VGOS proof-of-
19 concept implementation³², which acquires data on more than one hundred
20 channels with 32 MHz frequency bandwidth. Our array of selected frequen-
21 cies provides a sharply peaked delay resolution function (see Extended Data
22 Fig. 1), and the large bandwidth of each channel allows the unambigu-
23 ous determination of the absolute group delay using the technique of band-
24 width synthesis^{33,54}. Since the group delay has a linear phase slope over
25 frequency, a stable phase relation between adjacent channels is essential and
26 it is assured by a fully digital signal processing. We employ high-speed radio
27 frequency direct sampling⁵⁵ to digitize the signal without any analog fre-
28 quency conversions: the received signal is amplified, and then first converted
29 to digital data with a 16 384 MHz sampling rate via the high-speed sampler
30 K6/GALAS⁵². A digital filter implemented on a field programmable gate
31 array (FPGA) extracts the four signal channels with 1-bit sampling at 2048
32 megasamples per second for each polarization. Observation data is stored
33 on hard-disk drives at each station, and then transferred to the station at
34 Kashima over high-speed research networks for correlation processing.

35 **Node-hub style VLBI observations**

36 Transportable VLBI systems have previously been investigated for geodetic
37 VLBI^{56,57}, although their sensitivity is limited by the physical size of the
38 collecting area.

39 Our broadband observation system allows for smaller antennas by in-
40 creasing the observation bandwidth (Eq. 3). Yet, even in this case, the
41 transportable antenna pair does not have enough sensitivity for the reduced
42 correlated flux density on an intercontinental baseline. This is overcome by

1 combining the small transportable antennas (nodes) with a high sensitivity
 2 antenna (hub). The baseline between the smaller stations is then deduced by
 3 a closure delay relation⁵⁸. For two node stations A and B and a hub station
 4 R making an observation of a point-like radio source (see Extended Data
 5 Fig. 2) the time delay differences at time t for the arrival of an identical
 6 wave are related by the linear combination

$$\tau_{AB}(t) = \tau_{RB}(t) - \tau_{RA}(t) - \dot{\tau}_{AB}(t) \cdot \tau_{RA}(t). \quad (4)$$

7 Higher order terms in this relation are negligible for any terrestrial baselines
 8 when the radio source structure effect is negligible. The uncertainty of the
 9 delay τ_{AB} calculated in this way is still dominated by the contributions of
 10 instruments, atmosphere and source structure at the nodes as if the delay
 11 had been measured directly. In obtaining the delay observable of the AB
 12 baseline, the delay properties of station R such as atmospheric delay, cable
 13 length change, and gravitational deformation of the dish are canceled out.
 14 In our case, with both the hub and a transportable station separated by only
 15 110 km, Eq. 4 is still valid even in the presence of radio source structure,
 16 because the short baseline is insensitive while only the effect on the baseline
 17 AB is observed.

18 VLBI signal processing and analysis

19 The data reduction procedure for the VLBI observation consists of three
 20 steps for each of the node-hub baselines: first, the individual VH and VV
 21 polarization pairs for each frequency band are cross-correlated and time inte-
 22 gration is made using the software correlator GICO3⁵⁹ running on a cluster
 23 of computers. Second, synthetic cross-correlation data is generated by com-
 24 bining the VH and VV data such that correlation amplitudes are maximized
 25 for each scan and frequency band. Third, wideband bandwidth synthesis³³
 26 is applied to derive wideband group delay observables. Here we account
 27 for phase shifts of the propagating electromagnetic signal introduced by the
 28 ionospheric dispersive medium in the form of $\phi = A \cdot \delta_{\text{TEC}}/f$, where δ_{TEC}
 29 is the difference of total electron content (TEC) in the line of sight from
 30 each observation station, f is the radio frequency of the observations and
 31 A is a constant given by $e^2/(4\pi c \varepsilon_0 m_e)$, with ε_0 the vacuum electric permit-
 32 tivity and m_e the mass of the electron. The wideband bandwidth synthesis
 33 procedure calibrates ionospheric delay by simultaneously estimating δ_{TEC}
 34 and broadband group delay. Group delay data for all scans and baselines
 35 is stored in a Mark3 VLBI database. The virtual delays on the baseline
 36 between transportable antennas is analysed by a least-square fit using the
 37 Calc/Solve software⁶⁰. The parameters of the fit were the coordinates of
 38 one station, the atmospheric delay parameters for both stations as piece-
 39 wise linear functions with 60 minutes intervals and a single clock offset and
 40 clock rate.

1 The observed radio sources were selected from the recently proposed
 2 ICRF3 list⁶¹, which provides accurately known coordinates that predict the
 3 geometrical delays. The a-priori delay calculation includes relativistic coor-
 4 dinate transformation from the solar barycentric frame to a geocentric frame
 5 comoving with the Earth, accounting also for the gravitational time delay⁶².
 6 The excess path caused by dry atmosphere can be accurately predicted from
 7 air pressure on the ground, height, and latitude of the station⁶³. However,
 8 the distribution of water vapour is hard to predict from ground weather
 9 data, and the anisotropy of the atmosphere is difficult to estimate directly
 10 from the VLBI data because the east-west long baseline results in a limited
 11 sky coverage. Thus, we use the Vienna Mapping Functions 3 (VMF3)⁶⁴ for a
 12 priori delay calibration. The VMF3 are computed by ray tracing within a nu-
 13 merical weather model of the European Centre for Medium-Range Weather
 14 Forecasts (ECMWF). They include dry and wet components, as well as gra-
 15 dients, in the model data. Their data is publicly available and regularly
 16 computed for most space geodetic observation sites including Kashima, Ko-
 17 ganei, and Medicina. Residuals atmospheric contributions were estimated
 18 in the least-squares analysis of VLBI data.

19 **Uncertainty of the optical clocks, optical link and combs**

20 The operation of IT-Yb1 and NICT-Sr1 is similar and presented in detail in
 21 ref.^{34,35,42,65}. In both systems, an ultrastable clock laser is stabilized to the
 22 clock transition of atoms cooled to microkelvin temperatures and trapped
 23 in an optical lattice at the magic wavelength⁶⁶, 759 nm for ytterbium and
 24 813 nm for strontium. Frequency combs measure the clock laser relative to
 25 the local hydrogen masers.

26 For this campaign, the systematic frequency shifts of the clocks have been
 27 characterized with an uncertainty of 3.1×10^{-17} for IT-Yb1 and 8×10^{-17}
 28 for NICT-Sr1. The lattice light shift, density shift and static Stark shift are
 29 evaluated by interleaving measurements in different conditions. The black-
 30 body radiation shift is calculated from the temperature of the physics pack-
 31 age of each clock using known atomic parameters⁶⁷⁻⁶⁹, where the uncertainty
 32 is dominated by temperature inhomogeneity. We calculated from known
 33 atomic coefficients the lattice hyperpolarizability and multipolar shift⁷⁰⁻⁷²,
 34 the quadratic Zeeman shift^{1,72-76}, the background gas shift^{1,77} and the probe
 35 light shift^{1,78}.

36 At both laboratories, we determined the gravitational redshift with re-
 37 spect to the conventionally adopted gravity potential⁷⁹ $W_0 = 62\,636\,856.0 \text{ m}^2\text{s}^{-2}$.
 38 At INRIM, the redshift is calculated from a gravitational potential difference
 39 measured with a global navigation satellite system/geoid approach from the
 40 geoid model of Europe EGG2015^{80,81}, with an uncertainty of 3×10^{-18} cor-
 41 responding to about 3 cm in height. At NICT, the redshift is calculated from
 42 the geoid model of Japan GSIGEO2011⁸² with an uncertainty of 2×10^{-17} ,

1 which includes oscillations from tidal effects whose 10-day mean is less than
 2 15 cm in height.

3 The operation of the combs in Torino and Medicina and of the connecting
 4 optical link were monitored by redundantly tracking beatnotes to detect and
 5 remove cycle slips in the phase-locked loops. For this task, acquisition in
 6 Torino and Medicina was synchronized using the Network Time Protocol at
 7 better than 100 ms. The average number of cycle slips during the uptime
 8 was less than one per hour. The fibre-delivered laser is loosely phase locked
 9 to the hydrogen maser in Torino using the comb to avoid frequency drifts.
 10 In these conditions, the optical link contributes less than 1×10^{-18} after
 11 1000 s of averaging time^{41,83}.

12 For this measurement, the optical-to-microwave comparison at the combs
 13 in Torino, Medicina and Koganei has been evaluated at an uncertainty of
 14 8×10^{-17} each, while optical-to-optical comparisons are better character-
 15 ized⁸⁴ at less than 1×10^{-18} . We also conservatively estimated that each
 16 optical-to-microwave comparison at the comb introduces phase noise with a
 17 corresponding instability of 2×10^{-14} at 1 s of averaging time. The insta-
 18 bilities of the optical clocks are negligible compared to those of the maser
 19 frequency measurements, at about 2×10^{-15} at 1 s for the ytterbium clock
 20 and 7×10^{-15} at 1 s for the strontium clock.

21 **Uncertainty in the frequency chain**

22 The calculation of the frequency chain for the VLBI measurement of optical
 23 clocks follows the measurement model:

$$\frac{f(\text{Yb})}{f(\text{Sr})} = \frac{f(\text{Yb})}{f(\text{H}_T)} \frac{f(\text{H}_T)}{f(\text{H}_M)} \frac{f(\text{H}_M)}{f(\text{H}_K)} \frac{f(\text{H}_K)}{f(\text{Sr})}, \quad (5)$$

24 where the $f(\text{Yb})/f(\text{H}_T)$ is the frequency ratio between the ytterbium optical
 25 clock and the hydrogen maser in Torino measured at the comb, $f(\text{H}_T)/f(\text{H}_M)$
 26 is the frequency ratio between the masers in Torino and in Medicina mea-
 27 sured using the optical fibre link, $f(\text{H}_M)/f(\text{H}_K)$ is the frequency ratio be-
 28 tween the masers in Medicina and in Koganei measured using the VLBI
 29 comparison, and $f(\text{H}_K)/f(\text{Sr})$ is the frequency ratio between the hydrogen
 30 maser in Koganei and the strontium optical clock measured at the comb.

31 In the data analysis, each ratio r in Eq. (5) is expressed as a frac-
 32 tional deviation $y = r/r_0 - 1$, where r_0 is an arbitrary reference ratio. We
 33 chose the reference ratios for the clocks to be consistent with the recom-
 34 mended frequencies of ytterbium and strontium as secondary representa-
 35 tions of the second³⁷, $f_0(\text{Yb}) = 518\,295\,836\,590\,863.6(3)$ Hz and $f_0(\text{Sr}) =$
 36 $429\,228\,004\,229\,873.00(17)$ Hz. After linearization, the fractional correction
 37 of the result $y(f(\text{Yb})/f(\text{Sr}))$ can be calculated as the sum of the fractional
 38 corrections of each ratio.

1 The four frequency ratios in Eq. 5 were not measured simultaneously and
 2 need to be extrapolated to common intervals using the hydrogen masers as
 3 flywheel oscillators^{34,35,85}. After accounting for a linear drift, the dominant
 4 contribution to the extrapolation uncertainty is due to the stochastic maser
 5 behaviour^{42,43,86}. We model the maser noise with a power-law model⁸⁷ de-
 6 scribed by an Hadamard variance $\sigma_{\text{H}}^2 = h_{-2}(\tau/s)^{-2} + h_{-1}(\tau/s)^{-1} + h_0 +$
 7 $h_2(\tau/s)^2$. The coefficients h_j , conventionally identified with white phase
 8 noise, white frequency noise, flicker frequency noise and flicker-walk fre-
 9 quency noise respectively, are deduced from comparisons with the optical
 10 clocks or within the maser ensembles at INRIM and at NICT (see Extended
 11 Data Fig. 3b). The h_2 coefficient provides the best description of the long-
 12 term behaviour observed at NICT and it predominantly affects extrapola-
 13 tions over datasets longer than 10 d. There are no significant changes in the
 14 overall result if using an alternative set of coefficients that sets $h_2 = 0$ or re-
 15 places it with a best-fit h_1 coefficient associated with random-walk noise. We
 16 calculated the uncertainty due to dead time by Monte Carlo methods, using
 17 an algorithm for the generation of power-law noise⁸⁸ and simulating 500
 18 repeated averages over the time periods involved^{23,34,35,85}. The numerical
 19 calculations agree with analytic results based on the power spectral density
 20 of the modelled noise. The drift of each maser was determined from the com-
 21 parison with the optical clocks and extrapolations were calculated as $d\Delta t$,
 22 where d is the measured drift and Δt is the time difference of the barycentres
 23 of constituent data for the ratio under investigation. The averaging intervals
 24 were carefully selected to only include periods of well-characterized maser
 25 behavior. We note that we chose the averaging interval for each step of the
 26 chain aiming to minimize the final uncertainty for the ratio via VLBI (see
 27 Extended Data Fig. 3a).

28 The extrapolations have a typical uncertainty of 1×10^{-15} for each VLBI
 29 measurement in Fig. 2a. For the last point on MJD 58529, this contribution
 30 was reduced to 2.8×10^{-16} by operating all parts of the experiment simul-
 31 taneously, with residual extrapolation uncertainties only due to downtimes
 32 of the optical clocks and of the optical link.

33 At NICT, the VLBI station and the strontium optical clock were com-
 34 pared to different masers in the available ensemble. Using the continuously
 35 operated Japan Standard Time System⁸⁹, the conversion between masers
 36 can be calculated with a negligible uncertainty of 2×10^{-17} after 10^5 s of
 37 measurement time.

38 The measurement models for the frequency ratio via IPPP and for the
 39 closure difference between VLBI, optical link and IPPP employ a similar
 40 sequence of calculations but require different extrapolations. The closure
 41 calculation does not rely on optical clock data except through the extracted
 42 maser drifts.

1 **Averages and statistics of the frequency comparison**

2 In our analysis, we consider the covariance matrix between the various mea-
3 surements and calculate the weighted averages of Yb/Sr and closure ratios
4 with the Gauss-Markov theorem, or generalized least-squares fit^{90,91}. We
5 assume the systematic uncertainties of each clock and each comb as fully
6 correlated over time. In a limited number of cases, the same optical clock
7 data contribute to the ratio evaluation of more than one VLBI run (see
8 Extended Data Fig. 3a) and we account for this correlation.

9 For our measurements we averaged 190 h of ytterbium clock data, 790 h
10 of the optical link data, 300 h of VLBI sessions and GPS link, and 130 h of
11 strontium clock data. The Birge ratios⁹¹ for the weighted averages over 10
12 VLBI sessions are $\sqrt{\chi^2/n} = 1.07$ for the VLBI measurement, $\sqrt{\chi^2/n} = 0.90$
13 for the IPPP measurement, and $\sqrt{\chi^2/n} = 1.32$ for the closure, all with $n = 9$
14 degrees of freedom.

15 The Gauss-Markov method is used to establish optimal weights of the
16 data points for each of these measurements. The changing allocation of
17 weights results in a variation of overall uncertainty contributions (e.g., for
18 VLBI and IPPP in Table 1 and for the extrapolation in Extended Data
19 Figure 4) because the weights are calculated from the total uncertainty of
20 each measurement.

21 **Yb/Sr ratio via satellite link**

22 The ratio between the ytterbium clock and the strontium clock with the
23 satellite link reported in the main text only used data coinciding with VLBI
24 runs. We can average the GPS data to calculate a Yb/Sr frequency ratio
25 without this limitation, looking for the best overlap of ytterbium and stron-
26 tium data in the 130 d of the campaign. We calculated this ratio using both a
27 precise point positioning (PPP) solution and the IPPP solution over the en-
28 tire campaign (see Extended Data Fig. 4), resulting in frequency deviations
29 $y(\text{Yb/Sr}) = -2.4(4.0) \times 10^{-16}$ using PPP and $y(\text{Yb/Sr}) = -3.1(2.5) \times 10^{-16}$
30 using IPPP. For these measurements we averaged 180 h of ytterbium clock
31 data, 580 h of satellite transfer and 140 h of strontium clock data. The Birge
32 ratio for the weighted average of these measurements are $\sqrt{\chi^2/n} = 0.53$ for
33 PPP and $\sqrt{\chi^2/n} = 0.29$ for IPPP, both with $n = 9$ degrees of freedom. As
34 expected, IPPP results in a better uncertainty corresponding to a frequency
35 ratio $f(\text{Yb})/f(\text{Sr}) = 1.207\,507\,039\,343\,337\,38(30)$. The significantly longer
36 measurement time ultimately allows this measurement to achieve the same
37 uncertainty as the VLBI result.

1 **Acknowledgements**

2 Development of the broadband feed system was supported by Prof. Kenta
3 Fujisawa of Yamauchi University. We acknowledge Shingo Hasegawa, Yuka
4 Miyauchi of NICT/Kashima Space Technology Center, Fumimaru Naka-
5 gawa, Hiroshi Ishijima of NICT/Headquarters, and Takatoshi Ikeda of KDDI
6 Research Laboratory for their contribution to achieve this work. We thank
7 Alice Tabellini of IRA/INAF, Annalisa Dondi and Massimo Alberghini of
8 the Bologna Customs Agency for the management of the temporary im-
9 portation of the transportable VLBI antenna from Japan to Italy. The
10 broadband feeds were realized through the grant of Joint Development Re-
11 search on “Development of Broadband receiver system of Kashima 34m”
12 (2013-2015) supported by the Research Coordination Committee, National
13 Astronomical Observatory of Japan (NAOJ), National Institutes of Natural
14 Sciences (NINS). The development of the ytterbium optical clock and of the
15 optical link were supported by the European Metrology Program for Inno-
16 vation and Research (EMPIR) projects 15SIB03 OC18, 15SIB05 OFTEN,
17 17IND14 WRITE, 18SIB05 ROCIT; by the Italian Ministry of Education,
18 University and Research (LIFT and Metgesp projects); by the Horizon 2020
19 Marie Skłodowska-Curie Research and Innovation Staff Exchange (MSCA-
20 RISE) project Q-SENSE (Grant Agreement Number 691156). The EMPIR
21 initiative is co-funded by the European Union’s Horizon 2020 research and
22 innovation programme and the EMPIR Participating States. J.L. was sup-
23 ported by the French National Research Agency under the LABEX Cluster
24 of Excellence FIRST-TF (ANR-10-LABX-48-01). Fast data transfer from
25 Italy to Japan for quick turn around of the experiments was realized by sup-
26 port of high research networks JGN, Internet2, TransPAC, APAN, GEANT,
27 and GARR. IPPP results make use of the GINS software developed by the
28 French Space Agency CNES.

29 **Author’s contributions**

30 D.C., T.I., and M.S. designed, prepared and coordinated the experiment
31 with contributions from F.P. and F.L. M.S., K.T., H.U., M.T., J.K., and
32 R.I. designed and built the broadband VLBI system. M.S., K.T, H.U.,
33 M.T., E.K., K.N., Y.O., and R.T. set up and operated the VLBI stations in
34 Koganei and Kashima. M.S., K.T., M.T., H.U., K.N., Y.O., and R.T. set up
35 and operated the VLBI station in Medicina with support from G.M., M.R.,
36 C.B., G.Z., J.R., and F.P. M.P., F.B., and P.B. evaluated and operated the
37 ytterbium clock and the comb in Torino. C.C. and A.M. evaluated and
38 operated the optical fibre link and the combs in Torino and Medicina with
39 support from M.R. and C.B. H.H., N.N., and T.I. evaluated and operated
40 the strontium clock and the comb in Koganei. M.S., K.T., and T.K. carried

1 out the correlation analysis of the VLBI delay data. M.S., M.N., and R.R.
2 carried out the geodetic VLBI analysis. E.C., G.C., R.I., J.L., and G.P.
3 carried out the data analysis of the satellite links. M.P. and M.S. performed
4 the data analysis for the frequency comparisons with contributions from
5 N.N., C.C., J.L. and G.P. M.P. wrote the manuscript with support from
6 M.S., N.N., and C.C. All authors discussed the results and commented on
7 the paper.

8 **Competing interests**

9 The authors declare no competing interests.

10 **Data Availability**

11 The data that support the plots within this paper and other findings of this
12 study are available from the corresponding authors upon reasonable request.

Extended Data Table 1: VLBI sessions used for frequency comparison.

Date	Duration /h	Scans	Sources	Delay res. /ps	Rel. Freq. Unc.
14/10/2018	29	448	22	32	3.9×10^{-16}
04/11/2018	31	463	16	39	2.6×10^{-16}
14/11/2018	29	464	24	24	2.3×10^{-16}
24/11/2018	29	445	23	29	2.5×10^{-16}
04/12/2018	29	471	23	33	2.2×10^{-16}
15/12/2018	29	457	22	26	1.6×10^{-16}
25/12/2018	29	476	24	22	2.0×10^{-16}
15/01/2019	29	479	25	24	1.5×10^{-16}
25/01/2019	28	506	23	26	1.8×10^{-16}
14/02/2019	36	786	21	29	1.9×10^{-16}

a

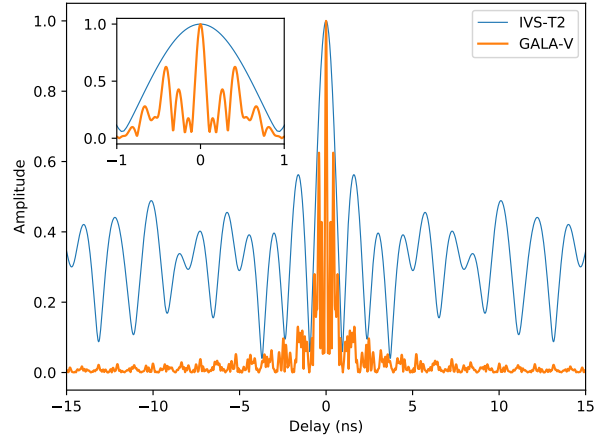

b

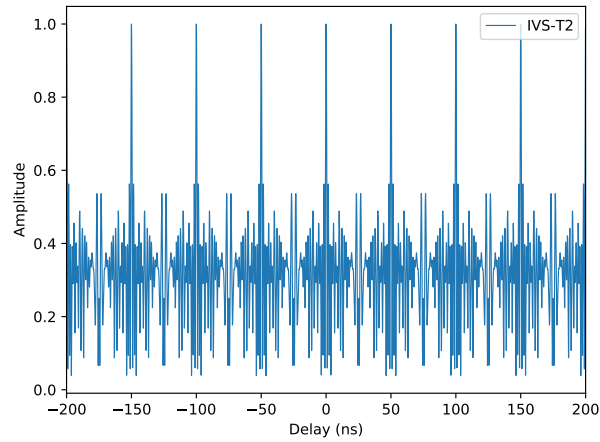

Extended Data Figure 1: Delay resolution function of GALA-V and standard geodetic VLBI (IVS-T2 session). **a**, Delay resolution functions for the frequency array of GALA-V described in the text and for standard geodetic VLBI (Experiment code T2126). GALA-V delay resolution function shows a single peak and fine delay resolution that allows the derivation of the absolute group delay without ambiguity. **b**, The delay resolution function formed from the frequency array of standard geodetic VLBI shows a delay ambiguity with a period equal to the reciprocal of the greatest common denominator of the frequency interval.

a

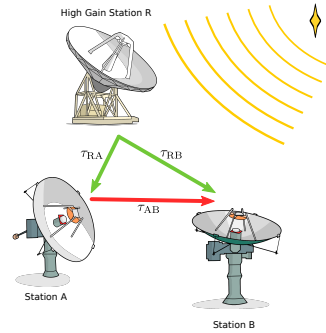

b

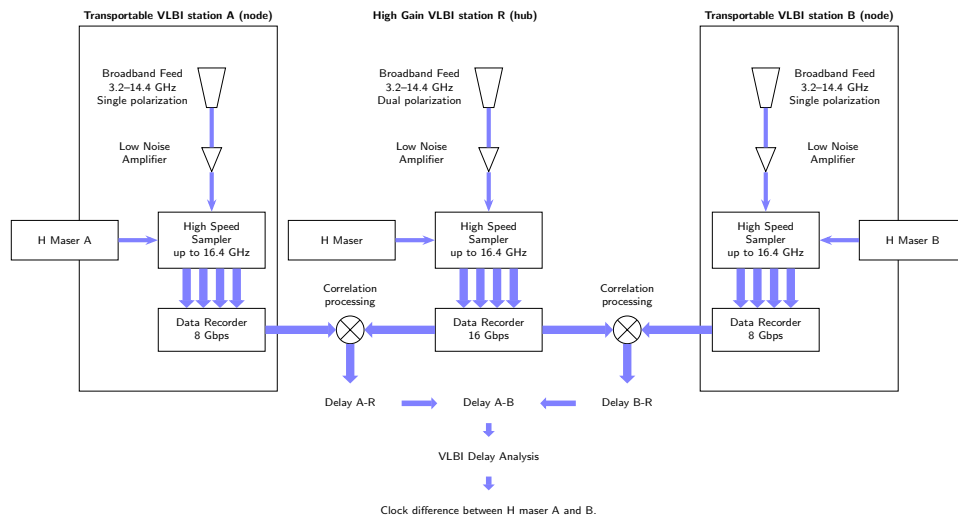

Extended Data Figure 2: Node-hub style observations with transportable broadband VLBI stations. **a**, Transportable small VLBI stations A and B can be used for intercontinental baseline by using a Node-hub style VLBI scheme with the station R. Delay data of AB baseline is computed by linear combination of delay data on RA and RB baselines. **b**, Block diagram of the Node-hub measurement with the broadband VLBI system.

a

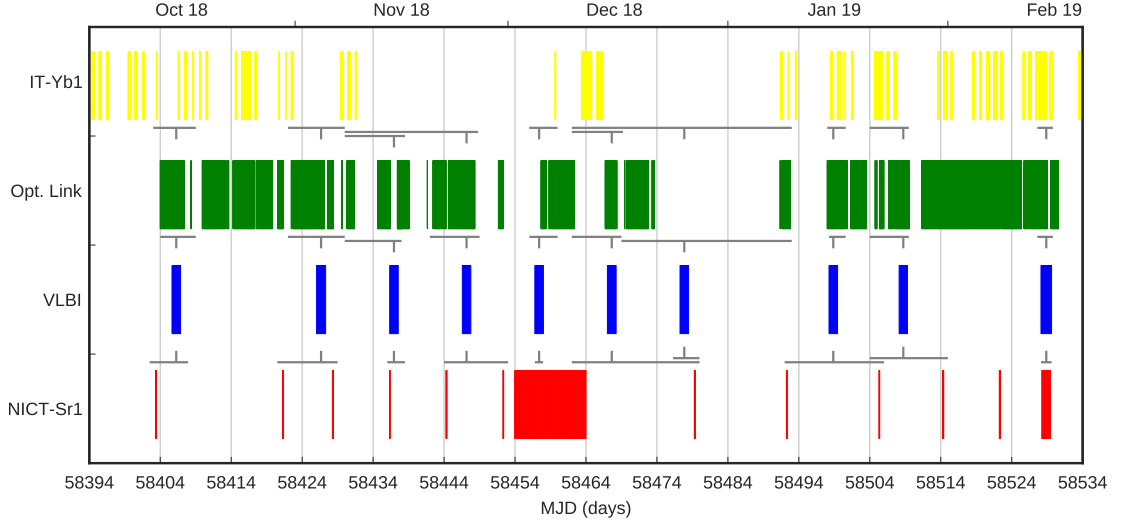

b

Maser	$h_{-2}^{1/2}$	$h_{-1}^{1/2}$	$h_0^{1/2}$	$h_2^{1/2}$
H_T	1.5×10^{-13}	3.5×10^{-14}	5×10^{-16}	2.5×10^{-22}
H_M	1.5×10^{-13}	2.8×10^{-14}	4×10^{-16}	2.5×10^{-22}
H_K	1.1×10^{-13}	4.5×10^{-14}	8×10^{-17}	2.5×10^{-22}

Extended Data Figure 3: Extrapolations over dead times using the masers as a flywheel. **a**, Uptimes of IT-Yb1 (yellow), optical link (green), VLBI link (blue) and NICT-Sr1 (red) marked as colored regions as a function of MJD. Gray horizontal bars represent evaluation intervals corresponding to each VLBI session, as marked by a vertical notch. For each evaluation interval the extrapolation was calculated for the masers at INRIM (between IT-Yb1 and the optical link), INAF (between the optical link and VLBI), and NICT (between VLBI and NICT-Sr1). **b**, Noise models used for extrapolations for the masers at INRIM, INAF, and NICT, describing the Hadamard variance $\sigma_H^2 = h_{-2}(\tau/s)^{-2} + h_{-1}(\tau/s)^{-1} + h_0 + h_2(\tau/s)^2$.

a

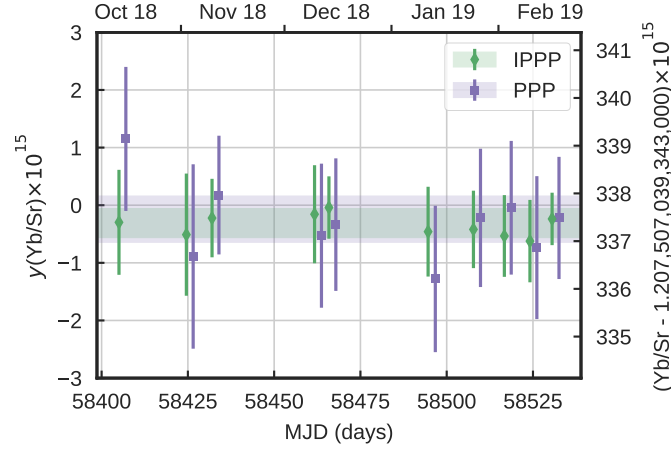

b

Yb/Sr ratio via PPP		Yb/Sr ratio via IPPP	
Contribution	Uncer. ($\times 10^{-16}$)	Contribution	Uncer. ($\times 10^{-16}$)
PPP satellite transfer	3.3	IPPP satellite transfer	1.4
Clocks	0.9	Clocks	0.9
Combs (microwave/optical)	1.1	Combs (microwave/optical)	1.1
Extrapolation	1.8	Extrapolation	1.4
Total	4.0	Total	2.5

Extended Data Figure 4: Yb/Sr frequency ratio measurements between INRIM and NICT measured with a GPS link using IPPP or PPP. **a**, Plot of the frequency ratio measurements. Green points represent the IPPP comparison with its total uncertainty. Green shaded region is the weighted mean of the IPPP comparison with its total uncertainty. Purple points represent the PPP comparison with its total uncertainty. Purple shaded region is the weighted mean of the PPP comparison with its total uncertainty. Horizontal offset between the two dataset is just for clarity. **b**, Uncertainty budget for the satellite comparisons.

1 References

- 2 [1] McGrew, W. F. *et al.* Atomic clock performance enabling geodesy
3 below the centimetre level. *Nature* **564**, 87–90 (2018). URL <https://doi.org/10.1038/s41586-018-0738-2>.
4
- 5 [2] Ushijima, I., Takamoto, M., Das, M., Ohkubo, T. & Katori, H. Cryo-
6 genic optical lattice clocks. *Nature Photonics* **9**, 185–189 (2015). URL
7 <http://dx.doi.org/10.1038/nphoton.2015.5>.
- 8 [3] Brewer, S. M. *et al.* $^{27}\text{Al}^+$ quantum-logic clock with a systematic uncer-
9 tainty below 10^{-18} . *Physical Review Letters* **123**, 033201 (2019). URL
10 <https://link.aps.org/doi/10.1103/PhysRevLett.123.033201>.
- 11 [4] Wynands, R. & Weyers, S. Atomic fountain clocks. *Metrologia* **42**, S64
12 (2005). URL <http://stacks.iop.org/0026-1394/42/i=3/a=S08>.
- 13 [5] Panfilo, G. & Arias, F. The coordinated universal time (UTC).
14 *Metrologia* **56**, 042001 (2019). URL [https://doi.org/10.1088/](https://doi.org/10.1088/2F1681-7575/2Fab1e68)
15 [2F1681-7575/2Fab1e68](https://doi.org/10.1088/2F1681-7575/2Fab1e68).
- 16 [6] Riehle, F., Gill, P., Arias, F. & Robertsson, L. The CIPM list of
17 recommended frequency standard values: guidelines and procedures.
18 *Metrologia* **55**, 188 (2018). URL [http://stacks.iop.org/0026-1394/](http://stacks.iop.org/0026-1394/55/i=2/a=188)
19 [55/i=2/a=188](http://stacks.iop.org/0026-1394/55/i=2/a=188).
- 20 [7] Sanner, C. *et al.* Optical clock comparison for Lorentz symmetry test-
21 ing. *Nature* **567**, 204–208 (2019). URL [https://doi.org/10.1038/](https://doi.org/10.1038/s41586-019-0972-2)
22 [s41586-019-0972-2](https://doi.org/10.1038/s41586-019-0972-2).
- 23 [8] Delva, P. *et al.* Test of special relativity using a fiber network of optical
24 clocks. *Physical Review Letters* **118**, 221102 (2017). URL [https://](https://link.aps.org/doi/10.1103/PhysRevLett.118.221102)
25 link.aps.org/doi/10.1103/PhysRevLett.118.221102.
- 26 [9] Takamoto, M. *et al.* Test of general relativity by a pair of transportable
27 optical lattice clocks. *Nature Photonics* (2020). URL [https://doi.](https://doi.org/10.1038/s41566-020-0619-8)
28 [org/10.1038/s41566-020-0619-8](https://doi.org/10.1038/s41566-020-0619-8).
- 29 [10] Godun, R. M. *et al.* Frequency Ratio of Two Optical Clock Tran-
30 sitions in $^{171}\text{Yb}^+$ and Constraints on the Time Variation of Funda-
31 mental Constants. *Physical Review Letters* **113**, 210801 (2014). URL
32 <http://link.aps.org/doi/10.1103/PhysRevLett.113.210801>.
- 33 [11] Huntemann, N. *et al.* Improved Limit on a Temporal Variation of
34 m_p/m_e from Comparisons of Yb^+ and Cs Atomic Clocks. *Physical*
35 *Review Letters* **113**, 210802 (2014). URL [http://link.aps.org/doi/](http://link.aps.org/doi/10.1103/PhysRevLett.113.210802)
36 [10.1103/PhysRevLett.113.210802](http://link.aps.org/doi/10.1103/PhysRevLett.113.210802).

- 1 [12] Delva, P., Denker, H. & Lion, G. *Relativistic Geodesy*, chap. Chrono-
2 metric Geodesy: Methods and Applications, 25–85 (Springer Inter-
3 national Publishing, Cham, 2019). URL [https://doi.org/10.1007/
4 978-3-030-11500-5_2](https://doi.org/10.1007/978-3-030-11500-5_2).
- 5 [13] Grotti, J. *et al.* Geodesy and metrology with a transportable optical
6 clock. *Nature Physics* **14**, 437–441 (2018). URL [https://doi.org/
7 10.1038/s41567-017-0042-3](https://doi.org/10.1038/s41567-017-0042-3).
- 8 [14] Bondarescu, R. *et al.* Ground-based optical atomic clocks as a tool
9 to monitor vertical surface motion. *Geophysical Journal Interna-*
10 *tional* **202**, 1770–1774 (2015). URL [https://doi.org/10.1093/gji/
11 ggv246](https://doi.org/10.1093/gji/ggv246). [http://oup.prod.sis.lan/gji/article-pdf/202/3/1770/
12 27716716/ggv246.pdf](http://oup.prod.sis.lan/gji/article-pdf/202/3/1770/27716716/ggv246.pdf).
- 13 [15] Derevianko, A. & Pospelov, M. Hunting for topological dark matter
14 with atomic clocks. *Nature Physics* **10**, 933– (2014). URL [https://doi.org/
15 //doi.org/10.1038/nphys3137](https://doi.org/10.1038/nphys3137).
- 16 [16] Kómár, P. *et al.* A quantum network of clocks. *Nature Physics* **10**,
17 582–587 (2014). URL <https://doi.org/10.1038/nphys3000>.
- 18 [17] Kolkowitz, S. *et al.* Gravitational wave detection with optical lattice
19 atomic clocks. *Phys. Rev. D* **94**, 124043 (2016). URL [https://link.
20 aps.org/doi/10.1103/PhysRevD.94.124043](https://link.aps.org/doi/10.1103/PhysRevD.94.124043).
- 21 [18] Lisdat, C. *et al.* A clock network for geodesy and fundamental science.
22 *Nature Communications* **7**, 12443– (2016). URL [http://dx.doi.org/
23 10.1038/ncomms12443](http://dx.doi.org/10.1038/ncomms12443).
- 24 [19] Clivati, C. *et al.* Optical frequency transfer over submarine fiber links.
25 *Optica* **5**, 893–901 (2018). URL [http://www.osapublishing.org/
26 optica/abstract.cfm?URI=optica-5-8-893](http://www.osapublishing.org/optica/abstract.cfm?URI=optica-5-8-893).
- 27 [20] Hachisu, H. *et al.* Direct comparison of optical lattice clocks
28 with an intercontinental baseline of 9000 km. *Optics Letters* **39**,
29 4072–4075 (2014). URL [http://ol.osa.org/abstract.cfm?URI=
30 ol-39-14-4072](http://ol.osa.org/abstract.cfm?URI=ol-39-14-4072).
- 31 [21] Riedel, F. *et al.* Direct comparisons of European primary and secondary
32 frequency standards via satellite techniques. *Metrologia* (2020). URL
33 <https://doi.org/10.1088/1681-7575/ab6745>. Not yet published in
34 print.
- 35 [22] Fujieda, M. *et al.* Advanced satellite-based frequency transfer at the
36 10-16 level. *IEEE Transactions on Ultrasonics, Ferroelectrics, and Fre-*
37 *quency Control* **65**, 973–978 (2018).

- 1 [23] Leute, J. *et al.* Frequency comparison of $^{171}\text{Yb}^+$ ion optical clocks
2 at PTB and NPL via GPS PPP. *IEEE Transactions on Ultrasonics,*
3 *Ferroelectrics, and Frequency Control* **63**, 981–985 (2016).
- 4 [24] Event Horizon Telescope Collaboration. First M87 event horizon tele-
5 scope results. I. the shadow of the supermassive black hole. *Astrophys-*
6 *ical Journal Letters* **875** (2019).
- 7 [25] Schuh, H. & Behrend, D. VLBI: a fascinating technique for
8 geodesy and astrometry. *Journal of Geodynamics* **61**, 68 – 80
9 (2012). URL [http://www.sciencedirect.com/science/article/
10 pii/S0264370712001159](http://www.sciencedirect.com/science/article/pii/S0264370712001159).
- 11 [26] Coates, R. J. & Clark, T. A. Worldwide time and frequency synchro-
12 nization by planned VLBI network. In *Proc. of the Sixth Ann. Precise*
13 *Time and Time Interval (PTTI) Planning Meeting*, 361–371 (1974).
- 14 [27] Clark, T. A. *et al.* Synchronization of clocks by very-long-baseline in-
15 terferometry. *IEEE Transactions on Instrumentation and Measurement*
16 **28**, 184–187 (1979).
- 17 [28] Hobiger, T., Rieck, C., Haas, R. & Koyama, Y. Combining GPS and
18 VLBI for inter-continental frequency transfer. *Metrologia* **52**, 251–
19 261 (2015). URL [https://doi.org/10.1088%2F0026-1394%2F52%
20 2F2%2F251](https://doi.org/10.1088%2F0026-1394%2F52%2F2%2F251).
- 21 [29] Koyama, Y. The use of very long baseline interferometry for time and
22 frequency metrology. *MAPAN* **27**, 23–30 (2012). URL [https://doi.
23 org/10.1007/s12647-012-0005-1](https://doi.org/10.1007/s12647-012-0005-1).
- 24 [30] Fey, A. L. *et al.* The second realization of the international celes-
25 tial reference frame by very long baseline interferometry. *The Astro-*
26 *nomical Journal* **150**, 58 (2015). URL [https://doi.org/10.1088%
27 2F0004-6256%2F150%2F2%2F58](https://doi.org/10.1088%2F0004-6256%2F150%2F2%2F58).
- 28 [31] Boehm, J., Werl, B. & Schuh, H. Troposphere mapping func-
29 tions for GPS and very long baseline interferometry from Euro-
30 pean Centre for Medium-Range Weather Forecasts operational anal-
31 ysis data. *Journal of Geophysical Research: Solid Earth* **111**
32 (2006). URL [https://agupubs.onlinelibrary.wiley.com/doi/
33 abs/10.1029/2005JB003629](https://agupubs.onlinelibrary.wiley.com/doi/abs/10.1029/2005JB003629). [https://agupubs.onlinelibrary.
34 wiley.com/doi/pdf/10.1029/2005JB003629](https://agupubs.onlinelibrary.wiley.com/doi/pdf/10.1029/2005JB003629).
- 35 [32] Niell, A. *et al.* Demonstration of a broadband very long baseline inter-
36 ferometer system: A new instrument for high-precision space geodesy.
37 *Radio Science* **53**, 1269–1291 (2018). URL [https://agupubs.
38 onlinelibrary.wiley.com/doi/abs/10.1029/2018RS006617](https://agupubs.onlinelibrary.wiley.com/doi/abs/10.1029/2018RS006617).

- 1 [https://agupubs.onlinelibrary.wiley.com/doi/pdf/10.1029/](https://agupubs.onlinelibrary.wiley.com/doi/pdf/10.1029/2018RS006617)
2 [2018RS006617](https://agupubs.onlinelibrary.wiley.com/doi/pdf/10.1029/2018RS006617).
- 3 [33] Kondo, T. & Takefuji, K. An algorithm of wideband band-
4 width synthesis for geodetic VLBI. *Radio Science* **51**, 1686–1702
5 (2016). URL [https://agupubs.onlinelibrary.wiley.com/doi/](https://agupubs.onlinelibrary.wiley.com/doi/abs/10.1002/2016RS006070)
6 [abs/10.1002/2016RS006070](https://agupubs.onlinelibrary.wiley.com/doi/abs/10.1002/2016RS006070). <https://agupubs.onlinelibrary.wiley.com/doi/pdf/10.1002/2016RS006070>.
7
- 8 [34] Pizzocaro, M. *et al.* Absolute frequency measurement of the $^1S_0 - ^3P_0$
9 transition of ^{171}Yb with a link to international atomic time. *Metrologia*
10 (2019). URL <https://doi.org/10.1088/1681-7575/ab50e8>. Not yet
11 published in print.
- 12 [35] Hachisu, H., Petit, G., Nakagawa, F., Hanado, Y. & Ido, T. SI-
13 traceable measurement of an optical frequency at the low 1×10^{-16}
14 level without a local primary standard. *Optics Express* **25**, 8511–
15 8523 (2017). URL [http://www.opticsexpress.org/abstract.cfm?](http://www.opticsexpress.org/abstract.cfm?URI=oe-25-8-8511)
16 [URI=oe-25-8-8511](http://www.opticsexpress.org/abstract.cfm?URI=oe-25-8-8511).
- 17 [36] Hachisu, H., Nakagawa, F., Hanado, Y. & Ido, T. Months-long
18 real-time generation of a time scale based on an optical clock. *Sci-*
19 *entific Reports* **8**, 4243– (2018). URL [https://doi.org/10.1038/](https://doi.org/10.1038/s41598-018-22423-5)
20 [s41598-018-22423-5](https://doi.org/10.1038/s41598-018-22423-5).
- 21 [37] Recommended values of standard frequencies for applications includ-
22 ing the practical realization of the metre and secondary representa-
23 tions of the definition of the second. URL [https://www.bipm.org/en/](https://www.bipm.org/en/publications/mises-en-pratique/standard-frequencies.html)
24 [publications/mises-en-pratique/standard-frequencies.html](https://www.bipm.org/en/publications/mises-en-pratique/standard-frequencies.html).
- 25 [38] Takamoto, M. *et al.* Frequency ratios of Sr, Yb, and Hg based optical
26 lattice clocks and their applications. *Comptes Rendus Physique* **16**,
27 489 – 498 (2015). URL [http://www.sciencedirect.com/science/](http://www.sciencedirect.com/science/article/pii/S1631070515000730)
28 [article/pii/S1631070515000730](http://www.sciencedirect.com/science/article/pii/S1631070515000730).
- 29 [39] Nemitz, N. *et al.* Frequency ratio of Yb and Sr clocks with 5×10^{-17}
30 uncertainty at 150 seconds averaging time. *Nature Photonics* **10**, 258–
31 261 (2016). URL <http://dx.doi.org/10.1038/nphoton.2016.20>.
- 32 [40] Udem, T., Holzwarth, R. & Hänsch, T. Femtosecond optical frequency
33 combs. *The European Physical Journal Special Topics* **172**, 69–79
34 (2009). URL <https://doi.org/10.1140/epjst/e2009-01042-6>.
- 35 [41] Clivati, C. *et al.* A VLBI experiment using a remote atomic clock
36 via a coherent fibre link. *Scientific Reports* **7**, 40992– (2017). URL
37 <https://doi.org/10.1038/srep40992>.

- 1 [42] Hachisu, H. & Ido, T. Intermittent optical frequency measurements to
2 reduce the dead time uncertainty of frequency link. *Japanese Journal*
3 *of Applied Physics* **54**, 112401 (2015). URL [http://stacks.iop.org/
4 1347-4065/54/i=11/a=112401](http://stacks.iop.org/1347-4065/54/i=11/a=112401).
- 5 [43] Grebing, C. *et al.* Realization of a timescale with an accurate op-
6 tical lattice clock. *Optica* **3**, 563–569 (2016). URL [http://www.
7 osapublishing.org/optica/abstract.cfm?URI=optica-3-6-563](http://www.osapublishing.org/optica/abstract.cfm?URI=optica-3-6-563).
- 8 [44] Petit, G. *et al.* 1×10^{-16} frequency transfer by GPS PPP with integer
9 ambiguity resolution. *Metrologia* **52**, 301–309 (2015). URL [https:
10 //doi.org/10.1088%2F0026-1394%2F52%2F2%2F301](https://doi.org/10.1088%2F0026-1394%2F52%2F2%2F301).
- 11 [45] Johnson, L. A. M., Gill, P. & Margolis, H. S. Evaluating the perfor-
12 mance of the NPL femtosecond frequency combs: agreement at the
13 10-21level. *Metrologia* **52**, 62–71 (2015). URL [https://doi.org/10.
14 1088%2F0026-1394%2F52%2F1%2F62](https://doi.org/10.1088%2F0026-1394%2F52%2F1%2F62).
- 15 [46] Xu, M. H. *et al.* Structure effects for 3417 celestial reference frame radio
16 sources. *The Astrophysical Journal Supplement Series* **242**, 5 (2019).
17 URL <https://doi.org/10.3847%2F1538-4365%2Fab16ea>.
- 18 [47] Bolotin, S. *et al.* The source structure effect in broadband observations.
19 In *Proc. of 24th Meeting of the European VLBI Group for Geodesy and*
20 *Astrometry* (2019).
- 21 [48] Riehle, F. Optical clock networks. *Nature Photonics* **11**, 25– (2017).
22 URL <https://doi.org/10.1038/nphoton.2016.235>.
- 23 [49] Fujieda, M. *et al.* Carrier-phase two-way satellite frequency transfer
24 over a very long baseline. *Metrologia* **51**, 253–262 (2014). URL [https:
25 //doi.org/10.1088%2F0026-1394%2F51%2F3%2F253](https://doi.org/10.1088%2F0026-1394%2F51%2F3%2F253).
- 26 [50] Laurent, P., Massonnet, D., Cacciapuoti, L. & Salomon, C. The
27 ACES/PHARAO space mission. *Comptes Rendus Physique* **16**,
28 540 – 552 (2015). URL [http://www.sciencedirect.com/science/
29 article/pii/S1631070515000808](http://www.sciencedirect.com/science/article/pii/S1631070515000808). The measurement of time / La
30 mesure du temps.
- 31 [51] Clark, T. A. *et al.* Precision geodesy using the Mark-III very-long-
32 baseline interferometer system. *IEEE Transactions on Geoscience and*
33 *Remote Sensing* **GE-23**, 438–449 (1985).
- 34 [52] Sekido, M. *et al.* An overview of the Japanese GALA-V wideband
35 VLBI system. In Behrend, D., Baver, K. D. & Armstrong, K. L. (eds.)
36 *IVS 2016 General Meeting Proceedings “New Horizons with VGOS”*,
37 NASA/CP-2016-219016, 25–33 (2016).

- 1 [53] Ujihara, H., Takefuji, K., Sekido, M. & Ichikawa, R. Development of
2 wideband antennas. In Freymueller, J. T. & Sánchez, L. (eds.) *International Symposium on Advancing Geodesy in a Changing World*, 25–28
3 (Springer International Publishing, Cham, 2019).
4
- 5 [54] Rogers, A. E. E. Very long baseline interferometry with large effective
6 bandwidth for phase-delay measurements. *Radio Science* **5**, 1239–1247
7 (1970). URL <https://agupubs.onlinelibrary.wiley.com/doi/abs/10.1029/RS005i010p01239>. <https://agupubs.onlinelibrary.wiley.com/doi/pdf/10.1029/RS005i010p01239>.
8
9
- 10 [55] Takefuji, K. *et al.* High-order sampling techniques of aliased signals
11 for very long baseline interferometry. *Publications of the Astronomical Society of the Pacific* **124**, 1105–1112 (2012). URL <https://doi.org/10.1086%2F668232>.
12
13
- 14 [56] Clark, T. A. Geodetic interferometry submission for the IUGG
15 quadrennial report reviews of geophysics and space physics. *Reviews of Geophysics* **17**, 1430–1437 (1979). URL <https://agupubs.onlinelibrary.wiley.com/doi/abs/10.1029/RG017i006p01430>.
16
17 <https://agupubs.onlinelibrary.wiley.com/doi/pdf/10.1029/RG017i006p01430>.
18
19
- 20 [57] Hase, H., Bäer, A., Riepl, S. & Schlüter, W. Transportable integrated
21 geodetic observatory (tigo). In *International VLBI Service for Geodesy and Astrometry 2000 General Meeting Proceedings*, 383–387 (2000).
22
- 23 [58] Xu, M. H. *et al.* The source structure of 0642+449 detected from the
24 CONT14 observations. *The Astronomical Journal* **152**, 151 (2016).
25 URL <https://doi.org/10.3847%2F0004-6256%2F152%2F5%2F151>.
- 26 [59] Kimura, M. Development of the software correlator for the VERA
27 system III. *IVS NICT-TDC News* **29**, 12–14 (2008).
- 28 [60] Gordon, D. *et al.* GSFC VLBI Analysis Center Report. In Baver,
29 K. D., Behrend, D. & Armstrong, K. L. (eds.) *International VLBI Service for Geodesy and Astrometry 2015+2016 Biennial Report*,
30 NASA/TP–2017–219021 (2017). URL http://ivscc.gsfc.nasa.gov/publications/br_2015_2016/index.html.
31
32
- 33 [61] International Astronomical Union (IAU). Resolution B2 of the thirtieth
34 general assembly of the IAU on the third realization of the international
35 celestial reference frame (2018). URL https://www.iau.org/administration/resolutions/general_assemblies/.
36
- 37 [62] Petit, G. & Luzum, B. IERS conventions (2010). IERS Technical
38 Note 36, International Earth Rotation and Reference Systems Service
39 (IERS), Frankfurt am Main (2010). ISBN 3-89888-989-6.

- 1 [63] Saastamoinen, J. *Atmospheric Correction for the Troposphere and*
2 *Stratosphere in Radio Ranging Satellites*, 247–251 (American Geophys-
3 ical Union (AGU), 2013). URL <https://agupubs.onlinelibrary.wiley.com/doi/abs/10.1029/GM015p0247>.
4 <https://agupubs.onlinelibrary.wiley.com/doi/pdf/10.1029/GM015p0247>.
5
- 6 [64] Landskron, D. & Böhm, J. VMF3/GPT3: refined discrete and empirical
7 troposphere mapping functions. *Journal of Geodesy* **92**, 349–360 (2018).
8 URL <https://doi.org/10.1007/s00190-017-1066-2>.
- 9 [65] Pizzocaro, M. *et al.* Absolute frequency measurement of the $^1S_0 - ^3P_0$
10 transition of ^{171}Yb . *Metrologia* **54**, 102 (2017). URL <http://stacks.iop.org/0026-1394/54/i=1/a=102>.
11
- 12 [66] Takamoto, M., Hong, F.-L., Higashi, R. & Katori, H. An optical lattice
13 clock. *Nature* **435**, 321–324 (2005). URL <http://dx.doi.org/10.1038/nature03541>.
14
- 15 [67] Sherman, J. A. *et al.* High-accuracy measurement of atomic polarizability
16 in an optical lattice clock. *Physical Review Letters* **108**, 153002 (2012). URL <http://link.aps.org/doi/10.1103/PhysRevLett.108.153002>.
17
18
- 19 [68] Beloy, K. *et al.* Atomic clock with 1×10^{-18} room-temperature
20 blackbody stark uncertainty. *Physical Review Letters* **113**, 260801
21 (2014). URL <http://link.aps.org/doi/10.1103/PhysRevLett.113.260801>.
22
- 23 [69] Middelmann, T., Falke, S., Lisdat, C. & Sterr, U. High accuracy cor-
24 rection of blackbody radiation shift in an optical lattice clock. *Physical*
25 *Review Letters* **109**, 263004 (2012). URL <http://link.aps.org/doi/10.1103/PhysRevLett.109.263004>.
26
- 27 [70] Nemitz, N., Jørgensen, A. A., Yanagimoto, R., Bregolin, F. & Ka-
28 tori, H. Modeling light shifts in optical lattice clocks. *Phys. Rev.*
29 *A* **99**, 033424 (2019). URL <https://link.aps.org/doi/10.1103/PhysRevA.99.033424>.
30
- 31 [71] Brown, R. C. *et al.* Hyperpolarizability and operational magic wave-
32 length in an optical lattice clock. *Physical Review Letters* **119**, 253001
33 (2017). URL <https://link.aps.org/doi/10.1103/PhysRevLett.119.253001>.
34
- 35 [72] Westergaard, P. G. *et al.* Lattice-induced frequency shifts in Sr
36 optical lattice clocks at the 10^{-17} level. *Physical Review Let-*
37 *ters* **106**, 210801 (2011). URL <http://link.aps.org/doi/10.1103/PhysRevLett.106.210801>.
38

- 1 [73] Ludlow, A. D. *et al.* Sr lattice clock at 1×10^{-16} fractional uncertainty
2 by remote optical evaluation with a Ca clock. *Science* **319**, 1805–
3 1808 (2008). URL [http://www.sciencemag.org/content/319/5871/
4 1805.abstract](http://www.sciencemag.org/content/319/5871/1805.abstract). [http://www.sciencemag.org/content/319/5871/
5 1805.full.pdf](http://www.sciencemag.org/content/319/5871/1805.full.pdf).
- 6 [74] Falke, S. *et al.* The ^{87}Sr optical frequency standard at PTB. *Metrologia*
7 **48**, 399 (2011). URL [http://stacks.iop.org/0026-1394/48/i=5/a=
8 022](http://stacks.iop.org/0026-1394/48/i=5/a=022).
- 9 [75] Bloom, B. J. *et al.* An optical lattice clock with accuracy and stability
10 at the 10-18 level. *Nature* **506**, 71–75 (2014). URL [http://dx.doi.
11 org/10.1038/nature12941](http://dx.doi.org/10.1038/nature12941).
- 12 [76] Nicholson, T. *et al.* Systematic evaluation of an atomic clock at
13 2×10^{-18} total uncertainty. *Nat Commun* **6**, – (2015). URL [http:
14 //dx.doi.org/10.1038/ncomms7896](http://dx.doi.org/10.1038/ncomms7896).
- 15 [77] Gibble, K. Scattering of cold-atom coherences by hot atoms: Fre-
16 quency shifts from background-gas collisions. *Physical Review Let-
17 ters* **110**, 180802 (2013). URL [http://link.aps.org/doi/10.1103/
18 PhysRevLett.110.180802](http://link.aps.org/doi/10.1103/PhysRevLett.110.180802).
- 19 [78] Baillard, X. *et al.* Accuracy evaluation of an optical lattice clock with
20 bosonic atoms. *Optics Letters* **32**, 1812–1814 (2007). URL [http://ol.
21 osa.org/abstract.cfm?URI=ol-32-13-1812](http://ol.osa.org/abstract.cfm?URI=ol-32-13-1812).
- 22 [79] General Conference on Weights and Measures (CGPM). Resolu-
23 tion 2 of its 26th meeting (2018). URL [https://www.bipm.org/en/
24 cgpm-2018/](https://www.bipm.org/en/cgpm-2018/).
- 25 [80] Margolis, H. *et al.* International timescales with optical clocks (ITOC).
26 In *European Frequency and Time Forum International Frequency Con-
27 trol Symposium (EFTF/IFC), 2013 Joint*, 908–911 (2013).
- 28 [81] Denker, H. *et al.* Geodetic methods to determine the relativistic redshift
29 at the level of 10^{-18} in the context of international timescales: a review
30 and practical results. *Journal of Geodesy* **92**, 487–516 (2018). URL
31 <https://doi.org/10.1007/s00190-017-1075-1>.
- 32 [82] Miyahara, B., Kodama, T. & Kuroishi, Y. Development of new hybrid
33 geoid model for Japan, “GSIGEO2011”. In *Bulletin of the Geospatial
34 Information Authority of Japan*, vol. 62 (2014).
- 35 [83] Clivati, C. *et al.* A coherent fiber link for very long baseline interferom-
36 etry. *IEEE Transactions on Ultrasonics, Ferroelectrics, and Frequency
37 Control* **62**, 1907–1912 (2015).

- 1 [84] Barbieri, P., Clivati, C., Pizzocaro, M., Levi, F. & Calonico, D. Spectral
2 purity transfer with 5×10^{-17} instability at 1 s using a multibranch
3 Er:fiber frequency comb. *Metrologia* (2019). URL [http://iopscience.
4 iop.org/10.1088/1681-7575/ab2b0f](http://iopscience.iop.org/10.1088/1681-7575/ab2b0f).
- 5 [85] Baynham, C. F. A. *et al.* Absolute frequency measurement of the op-
6 tical clock transition in with an uncertainty of using a frequency link
7 to international atomic time. *Journal of Modern Optics* **65**, 585–591
8 (2017). URL <https://doi.org/10.1080/09500340.2017.1384514>.
9 <https://doi.org/10.1080/09500340.2017.1384514>.
- 10 [86] Yu, D.-H., Weiss, M. & Parker, T. E. Uncertainty of a frequency com-
11 parison with distributed dead time and measurement interval offset.
12 *Metrologia* **44**, 91 (2007). URL [http://stacks.iop.org/0026-1394/
13 44/i=1/a=014](http://stacks.iop.org/0026-1394/44/i=1/a=014).
- 14 [87] Riley, W. J. Handbook of frequency stability analysis. NIST Spe-
15 cial Publication 1065, National Institute of Standards and Technology
16 (2008).
- 17 [88] Kasdin, N. J. & Walter, T. Discrete simulation of power law noise
18 (for oscillator stability evaluation). In *Proceedings of the 1992 IEEE*
19 *Frequency Control Symposium*, 274–283 (1992).
- 20 [89] Nakagawa, F., Imae, M., Hanado, Y. & Aida, M. Development of mul-
21 tichannel dual-mixer time difference system to generate UTC(NICT).
22 *IEEE Transactions on Instrumentation and Measurement* **54**, 829–832
23 (2005).
- 24 [90] Luenberger, D. G. *Optimization by Vector Space Methods* (Wiley, New
25 York, 1998).
- 26 [91] Margolis, H. S. & Gill, P. Least-squares analysis of clock frequency
27 comparison data to deduce optimized frequency and frequency ratio
28 values. *Metrologia* **52**, 628 (2015). URL [http://stacks.iop.org/
29 0026-1394/52/i=5/a=628](http://stacks.iop.org/0026-1394/52/i=5/a=628).