



ISTITUTO NAZIONALE DI RICERCA METROLOGICA Repository Istituzionale

In-field Raman amplification on coherent optical
fiber links for frequency metrology

Original

In-field Raman amplification on coherent optical
fiber links for frequency metrology / Clivati, Cecilia; Bolognini, G; Calonico, Davide; Faralli, S; Mura, A;
Levi, Filippo. - In: OPTICS EXPRESS. - ISSN 1094-4087. - 23:8(2015), pp. 10604-10615.
[10.1364/OE.23.010604]

Availability:

This version is available at: 11696/33164 since:

Publisher:

Optical Society of America

Published

DOI:10.1364/OE.23.010604

Terms of use:

This article is made available under terms and conditions as specified in the corresponding bibliographic
description in the repository

Publisher copyright

(Article begins on next page)

In-field Raman amplification on coherent optical fiber links for frequency metrology

C. Clivati,^{1,*} G. Bolognini,² D. Calonico,¹ S. Faralli,³ A. Mura,¹ and F. Levi¹

¹ Istituto Nazionale di Ricerca Metrologica INRIM, 10135, Torino, Italy

² Consiglio Nazionale delle Ricerche, IMM Institute, 40129 Bologna, Italy

³ Scuola Superiore Sant'Anna, TeCIP Institute, 56124 Pisa, Italy

*c.clivati@inrim.it

Abstract: Distributed Raman amplification (DRA) is widely exploited for the transmission of broadband, modulated signals used in data links, but not yet in coherent optical links for frequency metrology, where the requirements are rather different. After preliminary tests on fiber spools, in this paper we deeper investigate Raman amplification on deployed in-field optical metrological links. We actually test a Doppler-stabilized optical link both on a 94 km-long metro-network implementation with multiplexed ITU data channels and on a 180 km-long dedicated fiber haul connecting two cities, where DRA is employed in combination with Erbium-doped fiber amplification (EDFA). The performance of DRA is detailed in both experiments, indicating that it does not introduce noticeable penalties for the metrological signal or for the ITU data channels. We hence show that Raman amplification of metrological signals can be compatible with a wavelength division multiplexing architecture and that it can be used as an alternative or in combination with dedicated bidirectional EDFAs. No deterioration is noticed in the coherence properties of the delivered signal, which attains frequency instability at the 10^{-19} level in both cases. This study can be of interest also in view of the undergoing deployment of continental fiber networks for frequency metrology.

©2015 Optical Society of America

OCIS codes: (060.2360) Fiber optics links and subsystems; (120.3930) Metrological instrumentation; (290.5900) Scattering, stimulated Brillouin; (140.4480) Optical amplifiers; (060.4370) Nonlinear optics, fibers.

References and links

1. F. Levi, D. Calonico, C. E. Calosso, A. Godone, S. Micalizio, and G. A. Costanzo, "Accuracy evaluation of ITCsF2: a nitrogen cooled caesium fountain," *Metrologia* **51**(3), 270–284 (2014).
2. B. J. Bloom, T. L. Nicholson, J. R. Williams, S. L. Campbell, M. Bishof, X. Zhang, W. Zhang, S. L. Bromley, and J. Ye, "An optical lattice clock with accuracy and stability at the 10⁻¹⁸ level," *Nature* **506**(7486), 71–75 (2014).
3. I. Ushijima, M. Takamoto, M. Das, T. Ohkubo, and H. Katori, "Cryogenic optical lattice clocks," *Nat. Photonics* **9**(3), 185–189 (2015), doi:10.1038/NPHOTON.2015.5.
4. A. Amy-Klein, A. Goncharov, M. Guinet, C. Daussy, O. Lopez, A. Shelkovich, and C. Chardonnet, "Absolute frequency measurement of a SF₆ two-photon line by use of a femtosecond optical comb and sum-frequency generation," *Opt. Lett.* **30**(24), 3320–3322 (2005).
5. D. Gatti, A. Gambetta, A. Castrillo, G. Galzerano, P. Laporta, L. Gianfrani, and M. Marangoni, "High-precision molecular interrogation by direct referencing of a quantum-cascade-laser to a near-infrared frequency comb," *Opt. Express* **19**(18), 17520–17527 (2011).
6. M. Siciliani de Cumis, F. Cappelli, S. Bartalini, D. Mazzotti, S. Borri, A. Montori, N. Akikusa, M. Yamanishi, G. Giusfredi, P. Cancio, and P. De Natale, "Comb-assisted subkilohertz linewidth quantum cascade laser for high-precision mid-infrared spectroscopy," *Appl. Phys. Lett.* **102**(12), 121117 (2013).
7. C. W. Chou, D. B. Hume, T. Rosenband, and D. J. Wineland, "Optical clocks and relativity," *Science* **329**(5999), 1630–1633 (2010).
8. A. Bauch, J. Achkar, S. Bize, D. Calonico, R. Dach, R. Hlavac, L. Lorini, T. Parker, G. Petit, D. Piester, K. Szymaniec, and P. Urich, "Comparison between frequency standards in Europe and the USA at the 10⁻¹⁵

- uncertainty level,” *Metrologia* **43**(1), 109–120 (2006).
9. J. F. Cliche and B. Shillue, “Precision timing control for radioastronomy: maintaining femtosecond synchronization in the Atacama Large Millimeter Array,” *IEEE Contr. Syst. Mag.* **26**(1), 19–26 (2006).
 10. J. Kim, J. A. Cox, J. Chen, and F. X. Kärtner, “Drift-free femtosecond timing synchronization of remote optical and microwave sources,” *Nat. Photonics* **2**(12), 733–736 (2008).
 11. B. Chanteau, O. Lopez, W. Zhang, D. Nicolodi, B. Argence, F. Auguste, M. Abgrall, C. Chardonnet, G. Santarelli, B. Darquie, Y. Le Coq, and A. Amy-Klein, “Mid-infrared laser phase-locking to a remote near-infrared frequency reference for high-precision molecular spectroscopy,” *New J. Phys.* **15**(7), 073003 (2013).
 12. Y. He, B. J. Orr, K. G. H. Baldwin, M. J. Wouters, A. N. Luiten, G. Aben, and R. B. Warrington, “Stable radio-frequency transfer over optical fiber by phase-conjugate frequency mixing,” *Opt. Express* **21**(16), 18754–18764 (2013).
 13. M. Fujieda, M. Kumagai, and S. Nagano, “Coherent microwave transfer over a 204-km telecom fiber link by a cascaded system,” *IEEE Trans. Ultrason. Ferroelectr. Freq. Control* **57**(1), 168–174 (2010).
 14. L. Sliwczynski, P. Krehlik, A. Czubla, L. Buczek, and M. Lipiski, “Dissemination of time and RF frequency via a stabilized fibre optic link over a distance of 420 km,” *Metrologia* **50**(2), 133–145 (2013).
 15. O. Lopez, A. Amy-Klein, M. Lours, C. Chardonnet, and G. Santarelli, “High-resolution microwave frequency dissemination on an 86-km urban optical link,” *Appl. Phys. B* **98**(4), 723–727 (2010).
 16. G. Marra, R. Slavik, H. S. Margolis, S. N. Lea, P. Petropoulos, D. J. Richardson, and P. Gill, “High resolution microwave frequency transfer over a 86 km long optical fiber network using an optical frequency comb,” *Opt. Lett.* **36**(4), 511–513 (2011).
 17. B. Wang, C. Gao, W. L. Chen, J. Miao, X. Zhu, Y. Bai, J. W. Zhang, Y. Y. Feng, T. C. Li, and L. J. Wang, “Precise and continuous time and frequency synchronisation at the 5×10^{-19} Accuracy Level,” *Sci Rep* **2**, 556 (2012).
 18. K. Predehl, G. Grosche, S. M. F. Raupach, S. Droste, O. Terra, J. Alnis, Th. Legero, T. W. Hänsch, Th. Udem, R. Holzwarth, and H. Schnatz, “A 920-kilometer optical fiber link for frequency metrology at the 19th decimal place,” *Science* **336**(6080), 441–444 (2012).
 19. O. Lopez, A. Haboucha, B. Chanteau, Ch. Chardonnet, A. Amy-Klein, and G. Santarelli, “Ultra-stable long distance optical frequency distribution using the Internet fiber network,” *Opt. Express* **20**(21), 23518–23526 (2012).
 20. S. Droste, F. Ozimek, Th. Udem, K. Predehl, T. W. Hänsch, H. Schnatz, G. Grosche, and R. Holzwarth, “Optical-frequency transfer over a single-span 1840 km fiber link,” *Phys. Rev. Lett.* **111**(11), 110801 (2013).
 21. D. Calonico, E. K. Bertacco, C. E. Calosso, C. Clivati, G. A. Costanzo, M. Frittelli, A. Godone, A. Mura, N. Poli, D. V. Sutyryn, G. M. Tino, M. E. Zucco, and F. Levi, “High accuracy coherent optical frequency transfer over a doubled 642 km fiber link,” *Appl. Phys. B* **117**(3), 979–986 (2014).
 22. M. Fujieda, M. Kumagai, S. Nagano, A. Yamaguchi, H. Hachisu, and T. Ido, “All-optical link for direct comparison of distant optical clocks,” *Opt. Express* **19**(17), 16498–16507 (2011).
 23. S.-C. Ebenhag, P. O. Hedekvist, P. Jarlemark, R. Emardson, K. Jaldehag, C. Rieck, and P. Lothberg, “Measurements and error sources in time transfer using asynchronous fiber network,” *IEEE Trans. Instrum. Meas.* **59**(7), 1918–1924 (2010).
 24. F.-L. Hong, M. Musha, M. Takamoto, H. Inaba, S. Yanagimachi, A. Takamizawa, K. Watabe, T. Ikegami, M. Imae, Y. Fujii, M. Amemiya, K. Nakagawa, K. Ueda, and H. Katori, “Measuring the frequency of a Sr optical lattice clock using a 120 km coherent optical transfer,” *Opt. Lett.* **34**(5), 692–694 (2009).
 25. J. Vojtech, V. Smotlacha, P. Skoda, A. Kuna, M. Hula, and S. Sima, “Photonic services, their enablers and applications,” in *Proceedings of SPIE 8516, Remote Sensing System Engineering IV*, San Diego, California, 2012, p. 85160H.
 26. P. A. Williams, W. C. Swann, and N. R. Newbury, “High-stability transfer of an optical frequency over long fiber optic links,” *J. Opt. Soc. Am. B* **25**(8), 1284–1293 (2008).
 27. L.-S. Ma, P. Jungner, J. Ye, and J. L. Hall, “Delivering the same optical frequency at two places: accurate cancellation of phase noise introduced by an optical fiber or other time-varying path,” *Opt. Lett.* **19**(21), 1777–1779 (1994).
 28. L. Sliwczynski and J. Kołodziej, “Bidirectional optical amplification in long-distance two-way fiber-optic time and frequency transfer systems,” *IEEE Trans. Instrum. Meas.* **62**(1), 253–262 (2013).
 29. C. E. Calosso, E. Bertacco, D. Calonico, C. Clivati, G. A. Costanzo, M. Frittelli, F. Levi, A. Mura, and A. Godone, “Frequency transfer via a two-way optical phase comparison on a multiplexed fiber network,” *Opt. Lett.* **39**(5), 1177–1180 (2014).
 30. C. E. Calosso, E. K. Bertacco, D. Calonico, C. Clivati, G. A. Costanzo, M. Frittelli, F. Levi, S. Micalizio, A. Mura, and A. Godone, “Doppler-stabilized fiber link with 6 dB noise improvement below the classical limit,” *Opt. Lett.* **40**(2), 131–134 (2015).
 31. S. M. F. Raupach, A. Koczwar, and G. Grosche, “Optical frequency transfer via a 660 km underground fiber link using a remote Brillouin amplifier,” *Opt. Express* **22**(22), 26537–26547 (2014).
 32. C. Clivati, G. Bolognini, D. Calonico, S. Faralli, F. Levi, A. Mura, and N. Poli, “Distributed Raman optical amplification in phase coherent transfer of optical frequencies,” *Photon. Techn. Lett.* **25**(17), 1711–1714 (2013).
 33. J. Kim, D. Wu, G. Marra, D. J. Richardson, and R. Slavik, “Stability characterization of an optical injection phase locked loop for optical frequency transfer applications,” *Conference on Lasers and Electro-Optics*, San Jose, California, June 8–13 2014.

34. M. Islam, "Raman amplifiers for telecommunications," *J. Sel. Topics Quantum Electron.* **8**(3), 548–559 (2002).
35. A. Bercy, S. Guellati-Khelifa, F. Stefani, G. Santarelli, C. Chardonnet, P.-E. Pottie, O. Lopez, and A. Amy-Klein, "In-line extraction of an ultrastable frequency signal over an optical fiber link," *J. Opt. Am. Soc. B* **31**(4), 678–695 (2014).
36. S. W. Schediwy, D. Gozzard, K. G. H. Baldwin, B. J. Orr, R. B. Warrington, G. Aben, and A. N. Luiten, "High-precision optical-frequency dissemination on branching optical-fiber networks," *Opt. Lett.* **38**(15), 2893–2896 (2013).
37. G. Grosche, "Eavesdropping time and frequency: phase noise cancellation along a time-varying path, such as an optical fiber," *Opt. Lett.* **39**(9), 2545–2548 (2014).
38. G. Agrawal, *Nonlinear Fiber Optics*, 3rd ed. (Academic, 2001).
39. C. Clivati, A. Mura, D. Calonico, F. Levi, G. A. Costanzo, C. E. Calosso, and A. Godone, "Planar-waveguide external cavity laser stabilization for an optical link with 10^{-19} frequency stability," *IEEE Trans. Ultrason. Ferroelectr. Freq. Control* **58**(12), 2582–2587 (2011).
40. G. Bolognini, S. Faralli, A. Chiuchiarrelli, F. Falconi, and F. Di Pasquale, "High-power and low-RIN lasers for advanced first- and higher-order Raman co-pumping," *IEEE Photon. Technol. Lett.* **18**(15), 1591–1593 (2006).
41. L. Sliwczynski and P. Krehlik, "Measurement of acoustic noise in field-deployed fiber optic cables," Poster at European Frequency and Time Forum, Neuchatel, 2014.
42. S. T. Dawkins, J. J. McFerran, and A. N. Luiten, "Considerations on the measurement of the instability of oscillators with frequency counters," *IEEE Trans. On Ultrason., Ferroel., Freq. Contr.* **54**(5), 918–925 (2007).
43. F. Stefani, O. Lopez, A. Bercy, W.-K. Lee, C. Chardonnet, G. Santarelli, P.-E. Pottie, and A. Amy-Klein, "Tackling the Limits of Optical Fiber Links," arXiv:1412.2496.

1. Introduction

In the last twenty years, frequency metrology has progressively enabled the investigation of fundamental physics at new orders of magnitude. This happened thanks to many scientific and technical achievements: primary frequency standards and optical clocks are now respectively at the 2×10^{-16} and at the 1×10^{-18} level of uncertainty [1–3]; optical frequency combs cover an extremely broad spectrum, ranging from the visible to the terahertz region, and became a fundamental tool in spectroscopy [4–6]; the large variety of atomic species used in these experiments around the world is an enabling tool to prove fundamental theories [7]. However, improved frequency transfer techniques are required to cover the large geographical distances as an alternative to satellite methods [8]. This would bring a benefit not only to metrology and fundamental physics domains, but also to Very Long Baseline Interferometry (VLBI) [9], particle accelerators technology [10] and atomic and molecular spectroscopy [11].

Phase-stabilized optical fiber links are a viable solution; they are based on the transmission of a radio-frequency [12–17] or a continuous-wave, ultra narrow-linewidth optical signal [18–26] along a standard telecom fiber, phase-stabilized through the Doppler cancellation technique [27]. This avoids that random temperature variations and acoustic noise on the fiber affect the uncertainty of the delivered signal. It is interesting to note that only the phase variations which are experienced by the signal in both propagating directions can be efficiently compensated; therefore the optical signal must travel exactly the same optical path during the round trip. This is a key point for this technique and prevents from using telecom networks in the typical unidirectional transmission schemes. Standard telecom components such as Erbium Doped Fiber Amplifiers (EDFAs), isolators, circulators and so on, must be then avoided as they are clearly not suitable for metrological purpose. They are replaced by dedicated instrumentation such as bi-directional EDFA (b-EDFA), where optical isolators are removed to allow gain in both propagation directions [18, 19, 28].

During last years, attention has been paid to increasing the backbones robustness of metrological optical links and to ultra-long hauls bridging. The compatibility of this technique with a Wavelength Division Multiplexing (WDM) approach has been explored, autonomous and compact optical lasers systems have been developed [19], alternative techniques for the remote phase-comparisons [29,30] are under study and other amplification schemes are being investigated as an alternative to b-EDFA. Within this context, the most promising techniques are distributed Brillouin amplification (DBA) [31] and Raman amplification (DRA) [32], thanks to their intrinsic low noise and to the possibility of high gain levels. A novel technique based on injection locking has recently been reported as well [33].

DBA has been widely explored in the context of frequency dissemination. One of the most important issues of DBA is the narrow gain bandwidth (~20 MHz) which requires a careful frequency control of the pump laser, and the possibility to amplify only the signal which propagates in a direction opposite to the pump. These issues have been addressed by the latest technology developments, and autonomous turn-key DBA modules are now available [31].

On the contrary, DRA is extensively exploited in telecommunications. It is based on the Stimulated Raman Scattering (SRS) occurring in optical fibers between a high-power pump radiation and a frequency-downshifted signal (by 13.2 THz in silica glass fibers [34]). The gain bandwidth is significantly larger than in DBA; this avoids the need of frequency tuning the pump laser to achieve a stable gain and makes the amplifier barely insensitive to the frequency shifts involved in bidirectional optical links for metrology. In addition, DRA is intrinsically bidirectional, i.e. the amplification occurs whether the signal propagates in the same or in the opposite direction as the pump. For these reasons, DRA might be used in the intermediate amplification shelters of long optical links, where autonomous and robust operation are among the main requirements. The flexibility of DRA modules can make them a viable solution also for multi-user frequency distribution schemes [35–37]. On the other hand, due to the large bandwidth, DRA can provide a significant gain to WDM channels in addition to the metrological signal; thus, a careful design of amplification in frequency-multiplexed architectures is necessary to avoid cross-talk and gain depletion in WDM applications [38]. The efficiency of SRS is 6×10^{-13} m/W in standard single-mode fibers, meaning that pump power levels of several hundred mW are required to achieve a 20 dB gain. This is significantly higher than in DBA, where the typical gain coefficient is $\sim 5 \times 10^{-11}$ m/W [38]. The high pump power required by DRA might represent a drawback in some operating conditions, as it could lead to non-linear interactions between pump and signal such as self- and cross-phase modulation. The transfer of relative intensity noise (RIN) from pump to signal, which can be an issue in standard telecom systems [38], is a minor problem in the case of metrological signals, thanks to the extremely narrow bandwidth of the lightwave channel, as well as to the inherent phase-detection schemes in optical frequency transfer applications.

DRA-based optical frequency dissemination through real optical fibers then requires the experimental investigation of possible non-symmetrical phase shifts due to the interaction of pump and signal and of the compatibility with other users of the network [38].

In our previous work, we investigated the use of DRA for narrowband and high spectral purity optical signals and demonstrated its suitability for coherent optical fiber links. Our experiment was based on 200 km of fiber spools in a laboratory environment [32].

In this work, we further investigate this technique applied to real metrological links based both on a dark channel architecture where the fiber is shared with other data channels, and on a dark fiber architecture where only the metrological signal is present on the fiber. The experimental apparatus, the technical issues and the experimental results are described, demonstrating that DRA can be a viable alternative to other coherent amplification techniques and can be reliably adopted in long-haul metrological optical links, in WDM networks and in hybrid schemes in combination with bi-directional Erbium-doped fiber amplifiers.

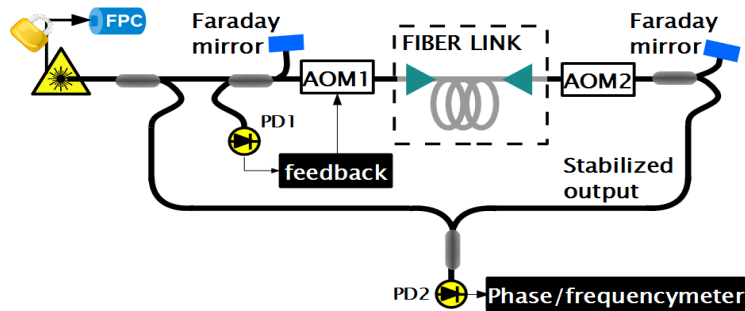

Fig. 1. Common experimental setup for optical link with phase-stabilization. Details of experiments with metro fiber link and inter-city fiber link are reported in Sec. 3 and Sec. 4 respectively. FPC: Fabry-Pérot cavity; AOM1 and AOM2: acousto-optic modulators; PD1 and PD2: photodiodes; triangles represent optical amplifiers.

2. Common experimental set-up

The common setup of our Raman-amplified optical link experiments is depicted in Fig. 1. Such a set-up has then been used in two different metrological experiments which will be detailed in the following sections, one involving a shared Raman-amplified fiber link with other data channels of the International Telecommunication Union grid, the second one involving a dedicated long-range fiber link with combined use of Raman amplifiers and b-EDFAs.

In the set-up of Fig. 1, an ultrastable laser frequency signal at 1542.14 nm is generated by locking a fiber laser to a high-finesse Fabry-Pérot cavity (FPC) with the Pound-Drever-Hall technique; the stabilized-laser linewidth is <30 Hz [39]. The laser signal is then split into two beams: one is used as a local oscillator, the other is coupled into the fiber, passes through the acousto-optic modulator AOM1 and travels the fiber to the remote link end. At the remote end, the lightwave signal is frequency-shifted by the acousto-optic modulator AOM2; a part of the signal is photo-received for extracting the optical frequency information, while a portion is reflected back by a Faraday mirror towards the near fiber-end. Here, the round-trip signal is compared to the original radiation through a heterodyne beatnote on the photodiode PD1; the coherent signal performing a round-trip is easily distinguished from the spurious back-reflections (e.g. Rayleigh backscattering) along the fiber thanks to the frequency shift induced by AOM2. The heterodyne beatnote on PD1 provides information about the phase noise experienced by the optical carrier in a double pass along the fiber; the phase fluctuations are then pre-compensated by a phase-locked loop (PLL) acting on AOM1. The pair of Faraday mirrors allows a stable polarization alignment of the round-trip signal with the local oscillator, avoiding beatnote fading and PLL-systems locking instability. The spectral purity and frequency instability of the signal delivered at the far fiber end are measured by comparing the delivered radiation with the original light on photodiode PD2; this is possible in our experiments since the in-field fiber (metro or inter-city) link undergoes a loop path, and the remote fiber-end is in the same building where also near fiber end and source laser are located.

3. Metro shared link (dark channel) experiment

The first experiment investigates the use of DRA to amplify metrological signals in common situations (e.g. urban metro fiber links) where there is availability only of a dark channel, and not of an entirely dedicated dark fiber. The metrological signal then shares the fiber link with other lightwave data channels. The experiment aims at assessing the impact of DRA and at verifying the absence of detrimental effects both for the metrological signal and for the data channels sharing the fiber link.

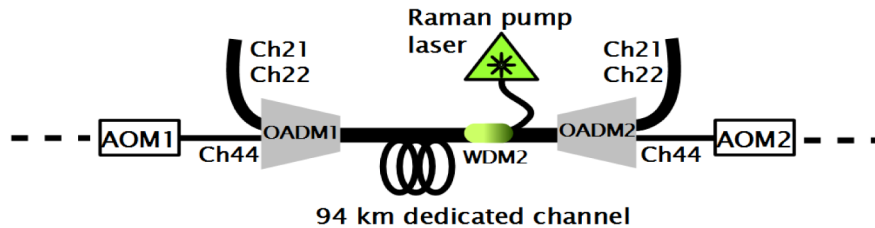

Fig. 2. Experimental setup used to evaluate DRA on a 94 km dedicated-channel optical link in the metropolitan area. A Raman pump laser is coupled at the remote fiber end through the Wavelength Division Multiplexer WDM2. AOM1 and AOM2: acousto-optic modulators; OADM1 and OADM2: optical add/drop multiplexers.

The configuration for this experiment is based on the common set-up shown in Fig. 1 for the transmission and photo-detection of the metrological signal; the specific implementation of the dark-channel fiber link in presence of Internet traffic is represented in Fig. 2.

The fiber metro-link shown in Fig. 2 is deployed along 94 km standard single-mode fiber throughout the metropolitan area of Turin (Italy), and is employed by the network operator for carrying 10 Gb/s data traffic with a Dense WDM (DWDM) architecture. The channel 44 of the International Telecommunication Union (ITU) grid is used by us for the coherent frequency transport (1542.14 nm), while the Internet traffic (managed by the network operator) occupies the ITU channels 21 and 22, at 1560.61 nm and 1559.79 nm respectively. The metro-loop is designed in such a way to have both near and far fiber-ends in our laboratory; this allows us to perform phase-noise and frequency-instability tests of the frequency delivery, rejecting the phase noise of our optical source. The metrological signal (-1 dBm input power) is injected and extracted to/from the optical fiber and separated by other WDM channels through optical add/drop multiplexers OADM1 and OADM2. The insertion loss of the input/output OADMs (5 dB each), together with the presence of connectors, bends and components along the 94 km path in the real metro environment, gives rise to a significantly high measured attenuation for the link, amounting to 54 dB.

A depolarized Raman pump laser at 1452 nm is used at the remote end [32], based on a commercial module that delivers up to ~ 800 mW into the fiber. The Optical Signal to Noise Ratio (OSNR) is larger than 50 dB in 0.1 nm resolution bandwidth. The average RIN value at low frequencies (< 10 MHz) for the pump laser is about -110 dB/Hz, that leads to a negligible effect when integrated on the narrow bandwidth (30 Hz) of the signal. The Raman pump is operated in cw constant power condition, without any frequency control. The pump laser is directly coupled into the multiplexed fiber to avoid optical filtering due to OADM2. The observed ON-OFF Raman gain for the ITU-44 metrological channel versus pump power is shown in Fig. 3 and amounts to ~ 23 dB for an input pump power of 0.97 W. This is the same gain we observe if the metro-fiber is replaced with fiber spools and indicates a good quality of the fiber loop.

It is important to note that large-bandwidth DRA also provides gain to the Internet data channels (ITU-21 and ITU-22) and then the use of DRA might improve or affect the ITU channel performance in terms of Bit Error Rate (BER), receivers saturation and so forth. It is necessary to take this into account in DRA design. During this experiment, the amplification of the optical carriers on channels 21 and 22, as well as the error rates, were constantly monitored throughout the whole network by the network manager company. For a pump power of 0.97 W a gain of 14 dB and 16 dB is observed on channels 21 and 22 respectively. During our experiments, no receiver saturation or BER deterioration is noticed in ITU data channels, thanks to the use of optical attenuators placed at network nodes and to the large dynamic range of the receivers in terms of admitted input power levels.

The gain provided by a single Raman amplifier at the remote link end is sufficient to enable a robust locking of the PLL and the frequency transfer of the ITU-44 metrological

signal at the 10^{-19} level of instability along the 94 km metro link. The results of this urban metro link experiment, in terms of attained phase noise and fractional frequency stability are shown in Section 5 and are compared to those obtained with the intercity (dark fiber) 180 km experiment, which is reported in next Section.

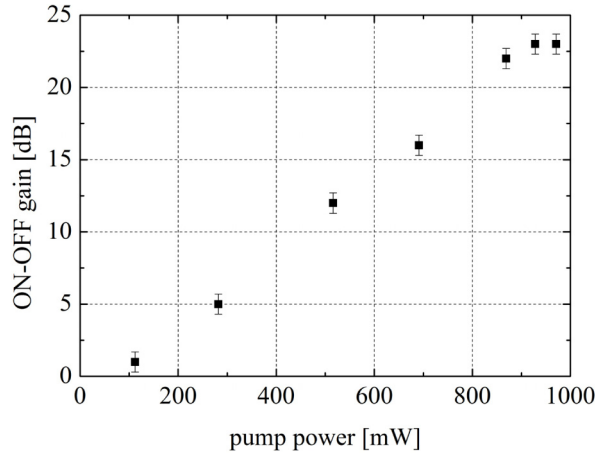

Fig. 3. Measured ON-OFF Raman gain for metrological signal at 1542.14 nm versus pump power.

4. Inter-city link (dark fiber) Raman-EDFA experiment

The second in-field experiment aims at assessing the capability of DRA to achieve ultra-long-distance frequency dissemination in a real link and at investigating the DRA behavior in combination with b-EDFAs. The configuration for this experiment is based on the common set-up shown in Fig. 1 for the transmission and photo-detection stages of the metrological signal, while the specific dedicated long-haul link is represented in Fig. 4. The link is actually based on a real inter-city link connecting the city of Turin with the neighboring town of Santhià (Italy), and exploits two dedicated fibers, each of whom is 90 km long. The fibers are connected together in Santhià to implement a 180 km long loop with both ends in our laboratory, where the signal is transmitted and independently received and the metrological characterization is carried out.

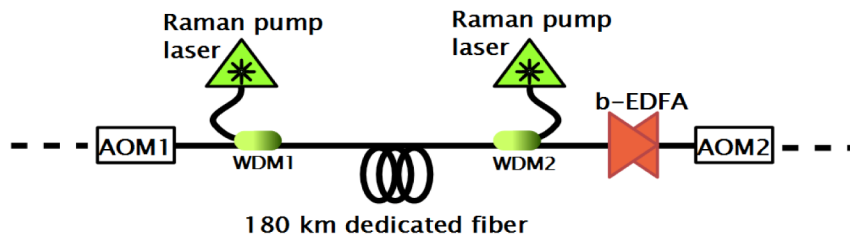

Fig. 4. The scheme used to evaluate DRA on a 180 km dedicated-fiber inter-city optical link. Two Raman amplifiers are used at the two link ends. AOM1 and AOM2: acousto-optical modulators; WDM1 and WDM2: wavelength division multiplexers.

The ultrastable laser signal is injected and extracted to/from the optical fiber (-1 dBm input power) and separated from the pump lights through two WDM couplers. The presence of connectors, bends and splices along the 180 km path in this case gives rise to total optical losses amounting to ~ 60 dB; hence, to provide higher overall gain, we use two DRA stages at opposite fiber ends, in bi-directional configuration. At the remote end, we use the Raman

pump laser described in Section 3, with an input power of 0.97 W; in addition, we also employ a couple of polarization-multiplexed Fabry-Pérot laser diodes at the local end [40], with a coupled power of 260 mW (OSNR \sim 58 dB in 0.1 nm resolution bandwidth). The average RIN value at low frequencies (<10 MHz) for the Fabry-Pérot laser diodes is about -140 dB/Hz, that leads also in this case to a negligible effect when integrated on the narrow bandwidth (30 Hz) of the signal. The Fabry-Pérot laser diodes are operated in cw constant power condition, without any frequency control. This device can provide a maximum ON-OFF gain of 9 dB in a laboratory testbed [32]. This gain is lower than what provided by the fiber Raman laser at remote end due to the lower maximum available pump power.

DRA is bidirectional and high bandwidth; therefore, each pump laser amplifies both the transferred signal and the round-trip signal, which is at nearly the same wavelength. This enables a robust locking of the PLL; nevertheless, amplification of the launched signal might induce Stimulated Brillouin Scattering (SBS) [38]. This is a detrimental effect occurring in standard single mode fibers for optical power higher than ~ 1 mW and causes a signal backreflection at ~ 80 pm lower wavelength. In these cases, a careful optimization of the pump and signal power levels is needed to avoid SBS excitation. This is not an issue for amplifiers located at the far link end where the signal, even if amplified, is very weak due to the link attenuation.

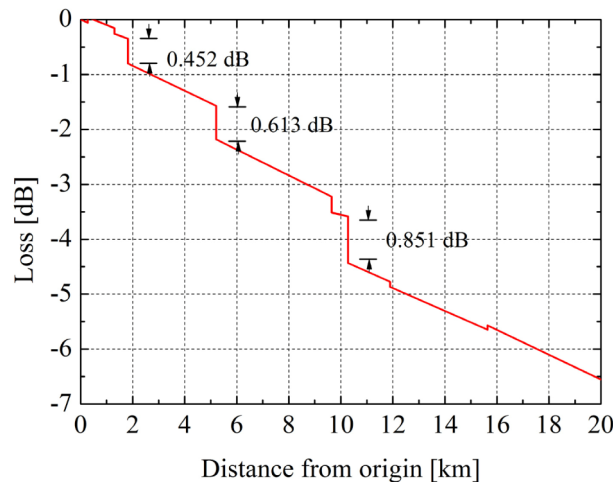

Fig. 5. OTDR trace along the first 20 km fiber in the inter-city link, with indication of significant loss events.

Interestingly, the gain achieved by these amplifiers can be significantly reduced with respect to theoretical expectations when using them on different real fiber links. Actually, the maximum ON-OFF gain observed for the remote pump in this experiment is 14 dB (lower than the 23 dB gain observed in the metro experiment) and the observed local pump gain is even lower (3 dB instead of 9 dB). This effect is well known in telecom networks and is related to high fiber losses near the pump input (i.e. within the pump effective length), which cause an abrupt pump power decrease and consequently a strong gain reduction. In order to verify this, we performed Optical Time Domain Reflectometry (OTDR) measurements and then numerically estimated the expected ON-OFF gain with the measured fiber loss values. OTDR measurements were taken along the first 20 km near fiber input and the last 20 km near fiber end, as with SMF-28 optical fiber links the connector losses located in the first ~ 22 km of fiber (i.e. within the DRA effective length) are the most relevant for DRA. The recorded OTDR trace is shown in Fig. 5 for the first 20 km of fiber, clearly indicating significant losses at about 2 km, 5 km and 10 km distance from the amplifiers. The loss values for the last 20 km of fiber link are nearly the same as the first 20 km, since, as explained

above, the fiber link travels a loop configuration, and both fibers are physically placed in the same cable.

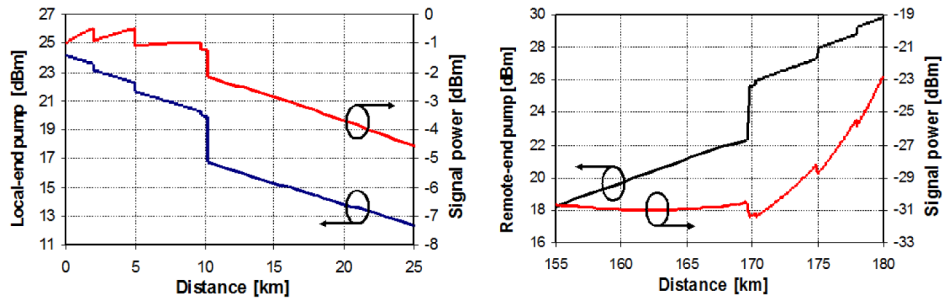

Fig. 6. Numerical estimate of the DRA signal-pump evolution based on OTDR loss measurements, along the first 25 km (on the left) and the last 25 km fiber spans (on the right).

With the recorded OTDR traces, we performed accurate numerical estimates of the signal/pump power evolution along the fiber, and of the resulting ON-OFF Raman gain. We employed a fully resolved spectral model of Raman amplifiers describing the power evolution of the two Raman pumps, an arbitrary number of signals, forward and backward Amplified Spontaneous Emission (ASE) components and Rayleigh scattering effects [38]. Results of simulations are shown in Fig. 6 (left) and Fig. 6 (right) for the first and last 20 km of fiber respectively, and indicate a strong impact of measured loss events in the DRA gain, leading to expected ON-OFF co-propagating and counter-propagating gain values of 3 dB and ~18 dB respectively, which is compatible with the real measured gain (3 dB and 14 dB). Note that the gain provided by DRA is experienced once by the transferred signal, but the benefits of DRA are doubled for the reflected signal which is fed back into the fiber by the Faraday mirror at fiber end in order to carry out phase noise stabilization. Actually, since Raman gain is bidirectional, DRA pumps provide gain also to this backward-propagating signal at nearly the same signal wavelength, thus giving a strong benefit in attaining locking of PLL at fiber input and achieving source phase noise stabilization.

Moreover, in this experiment a hybrid scheme was adopted, where a b-EDFA boosts the signal at the remote fiber end, just before AOM2 (see Fig. 4). The hybrid scheme allows us to investigate the synergy between the two techniques, providing higher overall gain without inserting amplifiers in the intermediate link shelters. For a b-EDFA pump current of 80 mA, a gain of 13 dB is obtained.

Such a configuration enables us to achieve robust operation and frequency dissemination across the 180 km link without intermediate amplification. The results are described in Section 5 and compared with the metro link performance.

It is important to stress that forcing high gains at the remote fiber end where the b-EDFA and the DRA are placed could trigger power oscillations and system instability. This is due to the combined effect of Rayleigh-scattered ASE of the b-EDFA and to reflections at the Faraday mirror. In fact, one of the well-known EDFAs limitations in a bidirectional set-up is the possibility to reach the lasing condition in presence of reflections on both ends of the EDFA and of losses compensation by the laser gain. If an EDFA is placed at the remote end of a link, close to the Faraday mirror, the end side after the EDFA obviously has not relevant losses and the Faraday mirror provides high reflection. Rayleigh back-scattering of the ASE in the fiber link provides optical feedback from the link side; the two combined effects lead to the lasing threshold even with very low EDFA gain. In this set-up the EDFA gain is limited to few dB.

5. Phase noise and frequency stability results

Phase noise spectrum and fractional frequency instability analysis of the delivered signal is of paramount importance in the assessment of the validity of DRA for metrological links. We were able to efficiently perform these measurements in both experiments (metro and inter-city links) thanks to the implementation of loop schemes, where the fiber end was delivered in the same laboratory where the fiber input was also located. Figure 7 shows the delivered signal phase noise as measured on PD2 in both experiments (metro and inter-city links). The graph actually reports the phase noise power spectrum during free-running (thin lines) and compensated (thick lines) operation of the link.

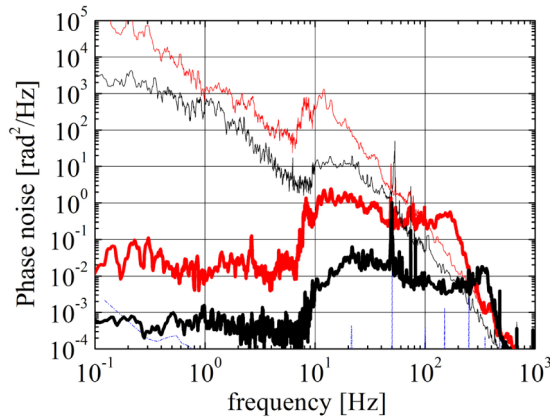

Fig. 7. Phase noise spectra of the free-running (thin traces) and compensated (thick traces) 94 km multiplexed link (black traces) and of the 180 km link on dedicated fiber (red traces), and interferometer noise floor (dotted blue thin line).

In both experiments, the free fiber noise shows a similar behavior, in particular a broad peak at about 20 Hz is observed; this is attributed to road traffic or air pipes in conditioning systems as suggested in [41]. The noise on the dedicated inter-city fiber link (180 km) exceeds by 10 dB the one in metro shared link (94 km), even if the link length is only about twice. This might be due to the fact that the 180 km fiber is buried along a heavy-traffic motorway. When the link is stabilized, the noise is expected to decrease by 50 dB at 1 Hz Fourier frequency on the 180 km link and by 55 dB on the 94 km link. These limits are given by the round-trip travel time of light into the fiber [26] and are in nice agreement with the obtained results of Fig. 7. No spectral purity deterioration is observed on the residual link noise due to Raman or hybrid amplification. The noise floor of this setup has been measured by replacing the optical link with an equivalent attenuator and is also shown in Fig. 7 (blue line). Under operational conditions, the cycle-slips rate is below 10^{-4} .

The fractional frequency instability of the transferred signal is evaluated in terms of the Allan deviation of frequency data acquired with a dead-time-free counter used in Lambda-mode [42] with 1 s averaging time. The results are shown in Fig. 8 for both experiments. On the short term, the stability is limited by the residual link phase noise, while on the long term it is due to the short fibers of the interferometer which cannot be compensated by the loop. This limitation could be furtherly mitigated as described in [43]. Nevertheless, an ultimate instability at the level of few parts in 10^{-19} can be obtained after few hours of operation. This is more than enough for the present requirements of optical links in most applications.

The accuracy of the link was assessed measuring the average value of the beatnote between the original and the delivered radiation. We did not observe any unexpected frequency offset at the level of the achieved instability, i.e. 5×10^{-19} .

The obtained results demonstrate that Raman amplification can be efficiently used for the coherent amplification of metrological signals in deployed links, both on dedicated and shared fibers with other data channels, without deterioration of data transmission on the neighboring channels. Moreover, this experimental work demonstrates a robust and performing operation of DRA also in hybrid schemes where b-EDFA are used at the remote link end to boost the collected signal power and performance. DRA can then efficiently enable the bridging of long fiber hauls without intermediate amplification shelters, while preserving a robust link operation. This is not always guaranteed with b-EDFA alone, which might lead to oscillations and instabilities if placed at the link ends and at high gain levels.

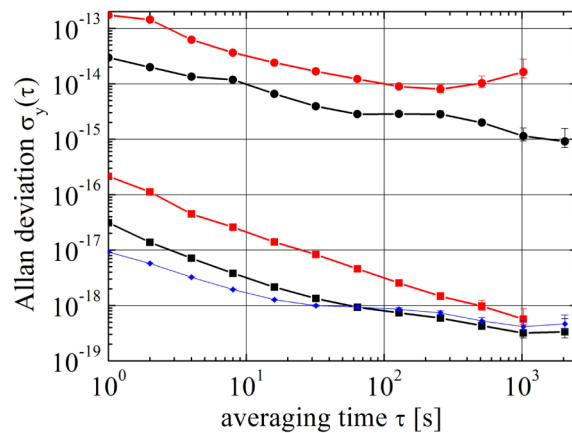

Fig. 8. Fractional frequency instability values of the non-compensated (black circles) and compensated (black squares) metro link (94 km), as well as instability values of the non-compensated (red circles) and compensated (red squares) inter-city link (180 km). The blue diamonds represent the interferometer noise floor.

7. Conclusions

In this work, we investigate the use of distributed Raman amplification in a coherent frequency link based on two experimental sessions, one involving a 94 km shared link with ITU channels carrying data traffic, the other one on a dedicated 180 km-long inter-city fiber link in combination with b-EDFAs. In the first shared link experiment, DRA for metrological applications shows a good compatibility with other ITU data channels lying within the amplifier gain bandwidth, also thanks to the inherent resilience and to the admittance range of standard telecom photoreceivers. In the inter-city long-haul fiber experiment, DRA shows promising synergy with b-EDFA, allowing for optical frequency transfer over an unrepeated 180 km link with no intermediate amplification stages. In both cases DRA proves not to affect the spectral purity of the delivered frequency signal, which attains frequency stability at the 10^{-19} level. A significant link-dependent gain behaviour is observed in our experiments, as also occurring in telecom networks, due to the infrastructure quality and in particular to the optical loss events in the first fiber kilometers. This affects the Raman pump power and the maximum achievable gain, indicating that a good knowledge of the optical fiber link is needed during the link design. Simulations have been performed to predict the attainable gain based on OTDR traces. The same procedure should be followed for optimizing the pump and signal power level along the haul, to prevent the arising of SBS and oscillations of the signal, especially at the local link end where the optical power is higher. Our experiments also pointed out that relatively high pump-power handling is not an issue (as also confirmed by common practice of DRA in standard telecom networks), and, despite the repeated connections/disconnections of several different fibers throughout the experiments, neither fiber damage nor detrimental back-reflections impacting metrological signal performance

have been observed. With the pre-requisite of a careful design for the specific link, and the evaluation of possible impairments, we show that DRA is very effective for an extensive use on optical fiber links for frequency metrology. In consideration of these results, we are planning to employ distributed Raman amplification in our recently developed optical fiber metrological link in Italy [21].

Acknowledgments

The authors are grateful to Paolo Cattaneo, Giancarlo Birello, Sandra Denasi, Andrea Salvati, and Consortium GARR for technical help with the fibers. This work was supported by the Italian Ministry of Research MIUR under Progetti Premiali Programme and by the European Metrology Research Programme (EMRP) under SIB-02 NEAT-FT and SIB-02 REG3. The EMRP is jointly funded by the EMRP participating countries within EURAMET and the European Union.