



ISTITUTO NAZIONALE DI RICERCA METROLOGICA Repository Istituzionale

DMMs as voltage ratio standards: a 20 years' report

Original

DMMs as voltage ratio standards: a 20 years' report / Capra, P. P.; Galliana, F.; Lanzillotti, M.; Sosso, A.; Durandetto, P.; RONCAGLIONE TET, L.; Francese, C.. - (2022), pp. 68-72. (Intervento presentato al convegno 25th IMEKO TC-4 international symposium on measurement of Electrical quantities 23rd international workshop on ADC and DAC modelling and testing tenutosi a brescia nel settembre 2022).

Availability:

This version is available at: 11696/74579 since: 2023-01-12T13:10:13Z

Publisher:

imeko

Published

DOI:

Terms of use:

This article is made available under terms and conditions as specified in the corresponding bibliographic description in the repository

Publisher copyright

(Article begins on next page)

DMMs as voltage ratio standards: a 20 years report

Pier Paolo Capra¹, Claudio Francese², Flavio Galliana³, Marco Lanzillotti⁴,
Luca Roncaglione Tet⁵, Andrea Sosso⁶ and Paolo Durandetto⁷.

^{1,2,3,4,5,6,7} *National Institute of Metrological Research INRIM), str. delle Cacce 91, 10135 Turin, Italy*

¹p.capra@inrim.it

²c.francese@inrim.it

³f.galliana@inrim.it

⁴m.lanzillotti@inrim.it

⁵l.roncaglione@inrim.it

⁶a.sosso@inrim.it

⁷p.durandetto@inrim.it

Abstract – At the National Institute of Metrological Research a convenient setup to verify the DMMs linearity has been developed. It consists in a top-class calibrated DC Voltage calibrator supplying directly the DMMs under test. Some Keysight 3458A, a Fluke 8508A and an 8588A DMMs are being enrolled in the tests. This setup is also compared with another setup with a Digital Analog Converter (R – 2R DAC) in place of the calibrator. The DMMs linearity is being verified both when DMMs are just switched on and at thermal regime. The interference of the input stages of the DMMs connected in parallel during the linearity measurements and the linearity by inverting the plug of one of the DMMs connected in parallel are currently under verification.

I. INTRODUCTION

Modern commercial high precision digital multimeters (DMMs) are widespread in primary and secondary calibration laboratories acting in very large fields of the five electrical quantities in low frequency (dc and ac voltage and current and dc resistance). They play a strategic role in the traceability transfer from National standards to secondary electrical laboratories, acting as primary reference standard for all quantities or as a traceability transfer [1]. Another important and useful feature of DMMs is their excellent linearity, mainly in the DC Voltage function, that in some cases is two orders of magnitude better than their accuracy specifications [2]. In addition, the linearity, or better, the deviation from linearity of a DMM, is not subjected to changes or drift, but it is instead an invariant parameter [3]. To measure the residual deviation from linearity of DMMs, the best method consists in directly connecting a Josephson Array Voltage Standard (JAVS), acting as voltage reference, to a DMM under test and measuring the voltage values read by the

DMM given increasing and decreasing of exactly known voltage steps provided by the JAVS [3, 4]. Unfortunately, this method is time consuming and not available in many laboratories and National Metrological Institutes (NMIs). For laboratories without JAVS, one or more JAVS-calibrated DMMs can be used to maintain a DC voltage ratio standard and used for voltage ratio traceability in mutual comparisons with a low noise digital to analog converter (DAC) [5,6,7] as common voltage source.

To that aim, two high precision voltage dividers and a measurement setup for calibration of DC voltage sources were developed at INRIM taking advantage of the linearity calibration of DMMs [8-10].

II. MULTIMETERS LINEARITY VS JOSEPHSON ARRAY

The linearity of modern digital multimeters requires, in order to be determined with sufficient accuracy, a system that generates DC voltages with stability better than $1 \cdot 10^{-8}$ during the measurement. The Josephson voltage standard is a quantum-based system capable of, generating accurate and low noise waveforms useful for characterization up to 10 V. While the accuracy specifications of multimeters are subject to deterioration over time and require regular calibration, linearity is maintained without deteriorating. The linearity shape of a multimeter is specific and uniquely identifies an instrument, exactly as fingerprints for humans. Figures 1 show the linearity shape of an HP3458 with option A measured against a Josephson array after 15 years. The graphs represent two fits where the reference voltage appears on the abscissa, while the ordinate is the measurement of the multimeter. After so many years the characteristics of the DMM did not change significantly and voltage measurements performed with a replacement technique, without a prior calibration of the multimeter

would lead to results with uncertainties of a few parts in 10^{-7} . In the following paragraphs, the comparison of linearity between different multimeters calibrated against the Josephson effect will be shown.

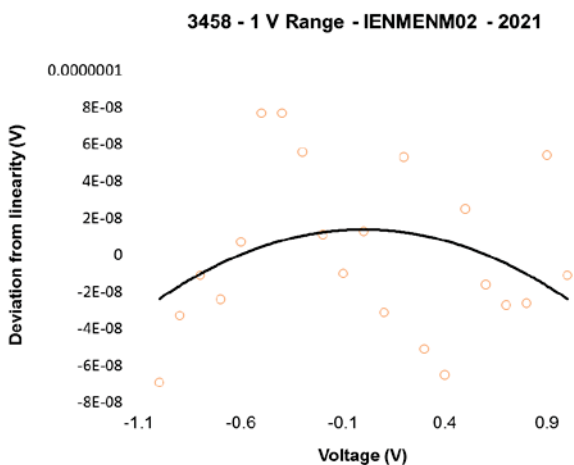
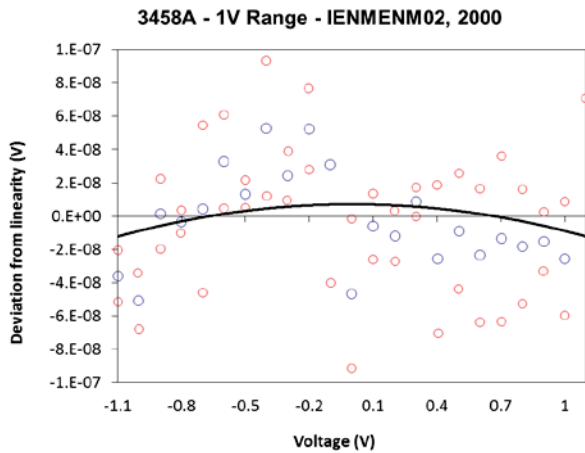

Fig. 1 (a & b). Linearity error of the same DMM measured over a time span of more than twenty years

II. MEASUREMENT METHOD

The circuit in our measurements is very straightforward: the output of the calibrator is applied to all DMMs under test connected in parallel. Then, for all relevant values, we generate several stable voltages and take the readings from all instruments. Assuming first, for the sake of simplicity, that offsets and thermal e.m.f.s. are constant, the voltages on all DMMs inputs are equal except for mutual offsets that are not changing in the measurement. Then, clearly all voltmeters are observing the same voltage increments.

The relative nonlinearity error is determined by first fitting linearly the readings of one DMM vs. one of the others. The nonlinear part of the relationship between the readings

is then obtained as the difference from the actual and the fit values. A secondary outcome of this method is an estimate of the DMM relative gain (gain error) and of the total voltage offset (constant term in the fit).

In reality, offsets and thermal e.m.f.s cannot be considered as constant at the sensitivity level required to estimate nonlinearities. Offsets drifting linearly with time can appear as a modified DVM gain or even nonlinear contributions if samples are not evenly spaced in time, and should be eliminated from result. In this case, the apparent contribution to slope due to drift can be canceled by taking a first set of readings with positive increments, then, a second one, backwards, with negative increments. This is basically the usual procedure for canceling offsets and linear drifts in measurements, applied to the fitting. For proper application of the method, any relevant drift should be checked to be linear and samples must be read with equal time interval separation to preserve linearity over time in sample sequence numbering. Averaging the forward-backward results, the only effect of the drift in the result is a change in the offset of the fit. However, since the DVM offset continuously changes with time, this is not a relevant parameter. For proper usage of a calibrated multimeter as ratio standard it must be either evaluated or canceled out in every measurement.

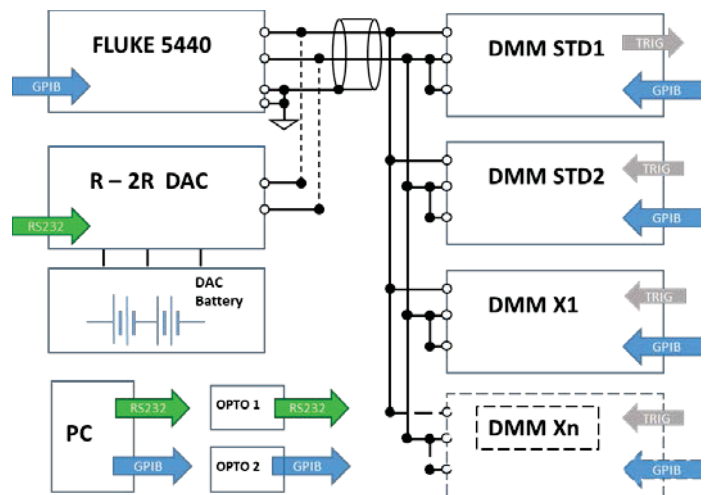

Fig. 2. Block diagram of the measuring system. The direct voltage is generated by two dc sources used alternately. The battery-powered R-2R DAC can generate low noise and fully floating voltages of ± 12 V while the FLUKE 5440 calibrator can operate up to 1000 V. All multimeters have the LO terminal connected to the guard system, while the ground reference is distributed by the calibrator. The measurement system is controlled by a computer via the IEEE4-488 BUS or the serial, both equipped with optical decoupling systems.

III. SETUP

The system used for the characterization of the multimeters is shown in Fig. 3. The station includes two units for the generation of dc voltage, one of the commercial type and the second specially designed at INRIM.



Fig. 3. The whole apparatus has been built inside a rack and, for clarity reasons, all the devices are shown together. In real measurement situations, to reduce both electrical and thermal noise, only the operative units are connected and powered. The side shields of the rack are normally removed to help with normal thermal cooling of the instruments

The FLUKE 5440 type dcv calibrator was chosen as the commercial unit. It is a DC voltage source with high stability and low noise, equipped with a GPIB connection. The second unit is a R-2R Digital to Analog Converter (R-2R DAC) controlled via an HC74595 shift-register connected to a microcontroller with an optical decoupling system and a serial port. This unit, by means of optical decoupling, is considerably quieter than normal commercial calibrators and the stability of the generated dc voltage is appropriate for the purposes described in the article. The two HP 3458 reference multimeters are placed

in the rack (at the top) and alternatively at the bottom are the multimeters being calibrated, all connected in parallel. The ground connection is distributed by the generator, while the multimeters are arranged in a floating manner with the Lo terminal connected to the Guard terminal. The cables used are shielded with connections with low thermo-electromotive forces.

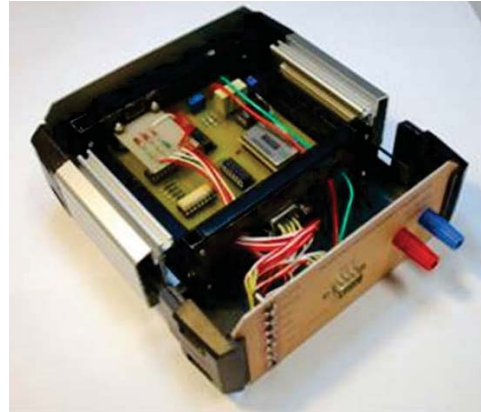

Fig. 4. The R-2R A/D converter unit is fully battery supplied and the digital control subcircuit is connected to the A/D conversion IC through opto-isolators. Thus the output wires, connecting the source to the voltmeters under test, are the only galvanic link to the outside environment in order to avoid ground loops.

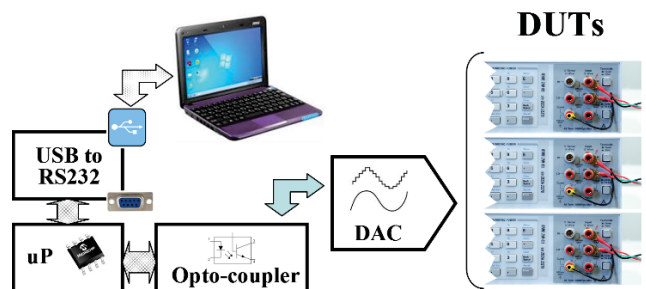

Fig. 5. The control system of the DAC consists of a USB-RS232 converter and a microcontroller, which generates the 16-bit control parameters. The digital part is powered through the computer's USB port. The 16-bit codes are sent serially to two 74LS595 shift registers connected directly to the DAC. The two Bytes stored in the shift registers are dumped with a single clock stroke in the DAC which updates the output voltage. The decoupling of the power supply is achieved by the opto-couplers, placed between the microprocessor and the shift registers. The connection of the DAC to the DMMs takes place with a connection as short as possible and equipped with terminations with low thermo-electromotive forces.

IV. DMMS COMPARISON

The two sample multimeters, calibrated against the

Josephson effect, are periodically compared with each other to verify that the linearity specifications are maintained. The graph in Fig 4 shows the linearity of two instruments, on the 10 V range and with the same settings used in the calibration phase. The linearity results obtained with a simple comparison measurement confirm the data derived from the JAVS calibration and do not change after months and after repeated “on and off” cycles.

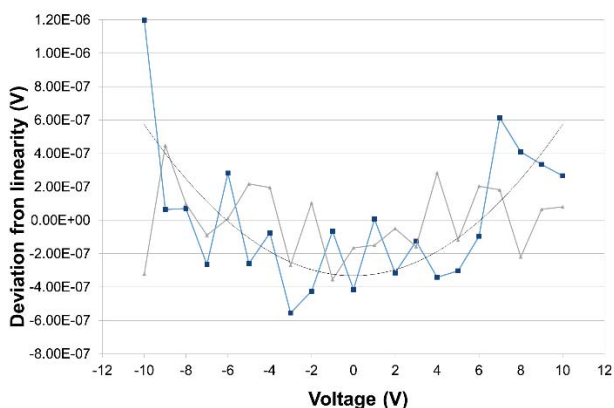

Fig. 6. Linearity comparison chart between two multimeters, both calibrated against JAVS. The linearity of the multimeters can therefore be verified not only with JAVS but also with calibrated instruments, obtaining uncertainties of about $5 \cdot 10^{-8}$.

V. SOFTWARE

The measurement system is completely automatic and is fully controlled by the IEEE-488 BUS except for the DAC which requires a dedicated controller. Starting from one / two multimeters calibrated against a JAVS system, up to 4 multimeters can be calibrated at the same time. Furthermore, the same system can also be used for verifying the linearity of the dc source used for the generation of the reference signal. The program developed can accept all the most common metrology grade DMMs.

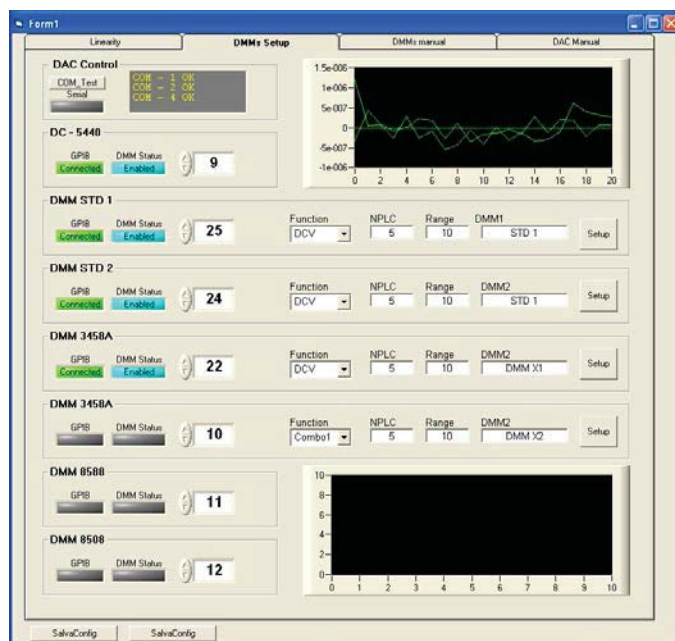

Fig. 7. The control program handles 1 or 2 multimeters calibrated by the JAVS and up to 4 under calibration. The settings are identical for all multimeters, but can be changed individually. The trigger signal can be managed via software or, more accurately, using the "Trigger" inputs the instruments are equipped with.

VI. CONCLUSIONS

The presented system allows to determine the linearity of high precision digital multimeters. The system is suitable both for laboratories equipped with a sample generation system based on the Josephson effect and for laboratories that do not have one and are working with DMMs calibrated vs JAVS.

The comparison of test carried out over about 20 years was presented and shown. We observed that the linearity characteristics of the multimeters do not change significantly over time, and always remains within the specifications declared by the manufacturers. The non-linearity values obtained on the DMMs tested are of a few parts in 10^{-8} and require reference signals of adequate stability. There is no evidence of cross-talk in connecting multiple multimeters in parallel, but experiments are still ongoing.

REFERENCES

- [1] C. Cassiagio, G. La Paglia, U. Pogliano, “Stability evaluation of high-precision multifunction instruments for traceability transfer”, IEEE Trans. Instrum. Meas. Vol. 50, No.6, December 2000, pp. 1206-1210.

- [2] Agilent Technologies, 3458A Multimeter-User's Guide, Revision: B.01, March 2001.
- [3] Helko E van den Brom et al, "Voltage linearity measurements using a binary Josephson system" Meas. Sci. Tech. Vol. 18, No. 11, September 2007, pp.3316-3320.
- [4] I. Giem, "Sub-ppm linearity testing of a DMM using a Josephson junction array," IEEE Trans. Instrum. Meas., Vol. 40 No. 2, 1991pp. 329-332.
- [5] R. Cerri, A. Sosso, P. P. Capra and L. Roncaglione, "Programmable source for DC voltage ratio calibration of DVMS" 17th Int. Cong. Metrology, 12008 (2015).
- [6] R. Cerri, A. Sosso, P. P. Capra "A low noise source for DC voltage ratio calibration of DVMS", in Proc. Elec. Conf. CPEM 2014, pp. 136-137.
- [7] A. Sosso and R. Cerri, "Calibration of multimeters as Voltage Ratio Standards", in Proc. Elec. Conf. CPEM 2000, pp. 375-376.
- [8] F. Galliana et al., "Automated precision DC voltage fixed ratios divider" Measurement 122, March 2018, pp. 291-296.
- [9] F. Galliana et al, "Automated setup to accurately calibrate electrical dc voltage generators", Measurement 123, July 2018, pp. 1291-134.
- [10] F. Galliana, R. Cerri, D. Corona, "Automatic DC voltage precision resistive divider with ratios between 10:1 and 10⁷:1, Measurement 183 October 2021, pp:1-10.